

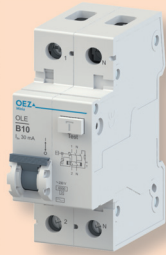







Modular devices

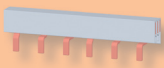

SUMMARY OF MODELS

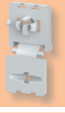
	Type AC		Type A
			
	page C6	page C9	page C10
Type	OLE	OLI	OLI
Function	Residual current circuit breakers with overcurrent protection		
Breaking capacity I_{cn} (EN 60898)	6 kA	10 kA	10 kA
Design	standard	standard / G	standard
Rated current I_n	6 ÷ 40 A	6 ÷ 40 A	6 ÷ 40 A
Rated residual current $I_{\Delta n}$	30 mA	30, 300 mA	30, 300 mA
Rated voltage U_e	AC 230 V	AC 230 V	AC 230 V
Number of poles	1N	1N	1N
Characteristics	B, C	B, C	B, C
Accessories			
Auxiliary switches 		PS-LT-1100-K PS-LT ¹⁾	
Signal switches 		SS-LT ¹⁾	
Shunt trips 		SV-LT ¹⁾	
Undervoltage releases 		SP-LT ¹⁾	
Remote control 		RC-LT	
Interconnecting busbars 		S2L, S2L+N, S3L+N	
Locking insert 		OD-LT-VU01	
Sealing insert 		OD-LT-VP01	
Handle adapter 		OD-OL-NR01	

¹⁾ Installation requires OD-OL-NR01 Handle adapter.

RESIDUAL CURRENT CIRCUIT BREAKERS WITH OVERCURRENT PROTECTION OLE

- The device is a combination of residual current circuit breaker and circuit breaker.
- Breaking capacity 6 kA.
- For protection:
 - against dangerous contact with live parts ($I_{\Delta n} \leq 30$ mA)
 - against dangerous contact with dead parts
 - against fire
 - against overload
 - against short-circuit.
- Tripping characteristics B, C according to EN 61009-1.
- Wide range of accessories – auxiliary and signal switches, undervoltage releases and shunt trips, interconnecting busbars.
- Double terminal with a fixed barrier in the middle enables comfort connection of conductors and interconnecting busbar from both sides of the device. It enables connection of:
 - conductors of various cross-sections
 - up to 4 conductors in the terminal
 - conductors of cross-section up to 35 mm².
- Double terminal enables easy check of conductors at simultaneous connection of interconnecting busbar - the interconnecting busbar does not cover the conductor connecting place - see description on page B4.
- Possibility of locking and sealing in off or on position.



OLE-10B-1N-030AC



Residual current circuit breakers with overcurrent protection, type AC



- They react to sine-wave residual current (type AC).
- They can be put out of operation by direct residual current.
- For building, housing and similar installations up to 40 A, AC 230 V.

$I_{\Delta n}$ [mA]	I_n [A]	Characteristic B		Characteristic C		Number of modules	Weight [kg]	Package [pcs]
		Type	Order code	Type	Order code			
30	6	OLE-6B-1N-030AC	OEZ:38313	OLE-6C-1N-030AC	OEZ:38320	2	0.25	1
	10	OLE-10B-1N-030AC	OEZ:38314	OLE-10C-1N-030AC	OEZ:38321	2	0.25	1
	16	OLE-16B-1N-030AC	OEZ:38315	OLE-16C-1N-030AC	OEZ:38322	2	0.25	1
	20	OLE-20B-1N-030AC	OEZ:38316	OLE-20C-1N-030AC	OEZ:38323	2	0.25	1
	25	OLE-25B-1N-030AC	OEZ:38317	OLE-25C-1N-030AC	OEZ:38324	2	0.25	1
	32	OLE-32B-1N-030AC	OEZ:38318	OLE-32C-1N-030AC	OEZ:38325	2	0.25	1
	40	OLE-40B-1N-030AC	OEZ:38319	OLE-40C-1N-030AC	OEZ:38326	2	0.25	1

Accessories

Auxiliary and signal switches	PS-LT, SS-LT ¹⁾	page B44
Shunt trips	SV-LT ¹⁾	page B45
Undervoltage releases	SP-LT ¹⁾	page B45
Remote control	RC-LT	page B46
Handle adapter	OD-OL-NR01	page B46
Locking insert	OD-LT-VU01	page B47
Sealing insert	OD-LT-VP01	page B47

¹⁾ Installation requires OD-OL-NR01 handle adapter.

Specifications

Type	OLE
Standards	EN 61009-1
Approval marks	
Number of poles	2
Tripping characteristics	B, C
Type	AC
Rated current	I_n 6 ÷ 16 A
Rated residual current	$I_{\Delta n}$ 30 mA
Rated operating voltage	U_e AC 230 V
Min. operating voltage ¹⁾	U_{min} AC 100 V
Max. operating voltage	U_{max} AC 255 V
Rated frequency	f_n 50 ÷ 60 Hz
Surge resistance (8/20 μ s)	1 kA
Rated short-circuit breaking capacity	I_{cn} 6 kA
Rated residual making and breaking capacity	$I_{\Delta m}$ 6 kA
Rated impulse withstand voltage (1.2/50 μ s)	U_{imp} 6 kV
Mechanical endurance	10 000 operating cycles
Electrical endurance	10 000 operating cycles
Energy limitation class	3
Degree of protection	IP20
Mounting on "U" rail according to EN 60715 – type	TH 35
Connection	
Conductor Cu	see table Connection range on page C7
Torque	2.5 ÷ 3 Nm
Top or bottom connection	top/bottom
Operating conditions	
Ambient temperature	-5 ÷ 40 °C
Working position	arbitrary

¹⁾ For preserving the function of the test push-button

RESIDUAL CURRENT CIRCUIT BREAKERS WITH OVERCURRENT PROTECTION OLE

Connection range

			Type and cross-section of conductor for rear side of the terminal														
			Interconnecting busbar	0.75 ÷ 10 mm ² 1x conductor rigid			25 mm ² 2x conductor rigid			0.75 ÷ 6 mm ² 1x conductor flexible ¹⁾			10 mm ² 2x conductor flexible ¹⁾		16 mm ² 1x conductor flexible with end sleeve		0.75 ÷ 6 mm ² 2x conductor flexible with end sleeve
Type and cross-section of conductor for front side of the terminal	1x conductor rigid	0.75 ÷ 16 mm ²	✓	✓	✓	✗	✓	✓	✓	✗	✓	✓	✓	✓	✗	✓	✓
		25 mm ²	✓	✓	✗	✗	✓	✓	✓	✗	✓	✓	✓	✗	✗	✓	✓
		35 mm ²	✓	✗	✗	✗	✗	✓	✓	✗	✓	✓	✓	✗	✗	✓	✗
	2x conductor rigid	0.75 ÷ 10 mm ²	✓	✓	✓	✓	✓	✓	✓	✓	✓	✓	✓	✓	✓	✓	✓
		25 mm ²	✓	✓	✗	✗	✓	✓	✓	✗	✓	✓	✓	✗	✗	✓	✓
	1x conductor flexible ¹⁾	1 ÷ 16 mm ²	✓	✓	✓	✗	✓	✓	✓	✗	✓	✓	✓	✓	✗	✓	✓
		25 mm ²	✓	✓	✗	✗	✓	✓	✓	✗	✓	✓	✓	✓	✗	✓	✓
2x conductor flexible ¹⁾	1 ÷ 6 mm ²	✓	✓	✓	✗	✓	✓	✓	✗	✓	✓	✓	✓	✗	✓	✓	
	25 mm ²	✓	✓	✗	✗	✓	✓	✓	✗	✓	✓	✓	✓	✗	✓	✓	
1x conductor flexible with end sleeve	0.75 ÷ 16 mm ²	✓	✓	✗	✗	✓	✓	✓	✗	✓	✓	✓	✓	✗	✓	✓	
	25 mm ²	✓	✓	✓	✗	✓	✓	✓	✗	✓	✓	✓	✓	✗	✓	✓	
2x conductor flexible with end sleeve	0.75 ÷ 6 mm ²	✓	✓	✓	✗	✓	✓	✓	✗	✓	✓	✓	✓	✗	✓	✓	
	25 mm ²	✓	✓	✓	✗	✓	✓	✓	✗	✓	✓	✓	✓	✗	✓	✓	

¹⁾ The conductor must be twisted before insertion to a terminal; individual conductor fibres must not stick out of the terminal. Conductors of the same type and cross-section must be used for connection of two conductors to the same level of a terminal.

Internal impedance Z and powers losses P

I _n [A]	Characteristic B			Characteristic C		
	L-Pole Z [mΩ]	N-Pole Z [mΩ]	Power loss P [W/pole]	L-Pole Z [mΩ]	N-Pole Z [mΩ]	Power loss P [W/pole]
6	72	2.1	2.7	52	2.1	1.9
10	15.4	2.1	1.8	13.4	2.1	1.6
16	9.6	2.1	3	8.7	2.1	2.8

Correction of rated currents

I _n [A]	Correction of rated currents for ambient temperature -10 °C up to +40 °C [A] ²⁾					
	-10 °C	0 °C	10 °C	20 °C	30 °C	40 °C
6	6.8	6.7	6.4	6.2	6	5.7
10	11.4	11.2	10.7	10.4	10	9.5
16	18.2	17.9	17.1	16.6	16	15.2

²⁾ Reference temperature: 30 °C

Dimensions

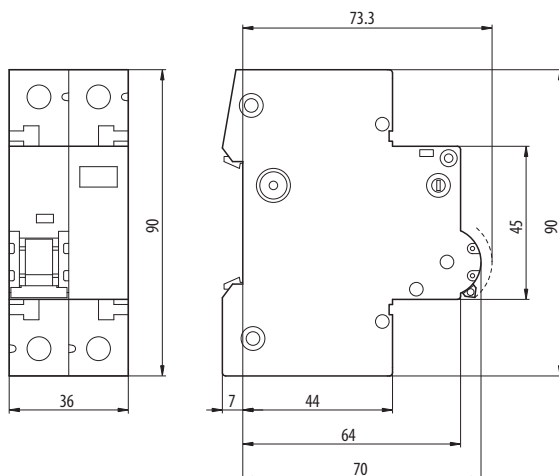

Diagram

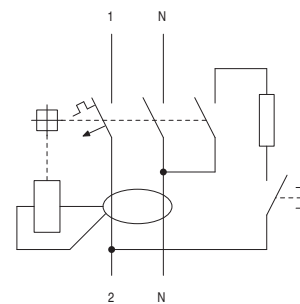

RESIDUAL CURRENT CIRCUIT BREAKERS WITH OVERCURRENT PROTECTION OLE

Characteristics

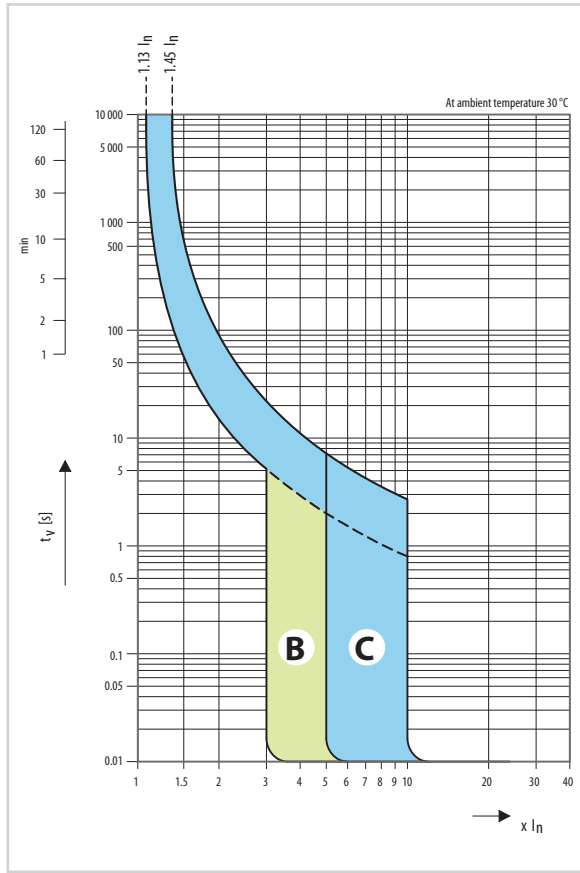

- **Characteristic B:** for protection of line of electrical circuits with equipment, which does not cause current surges. The short-circuit release is set to $(3 \div 5) I_n$.
- **Characteristic C:** for protection of line of electrical circuits with equipment, which causes current surges. The short-circuit release is set to $(5 \div 10) I_n$.

Tripping characteristics of circuit breakers according to EN 61009-1

Thermal release	Tripping characteristic type
	B, C
Conventional non-tripping current I_m for $t \geq 1$ hr	$I_m = 1.13 I_n$
Conventional tripping current I_t for $t < 1$ hr	$I_t = 1.45 I_n$
Current I_3 for $1 s < t < 60 s$ and $I_n \leq 32 A$	$I_3 = 2.55 I_n$

t - break time of the circuit breaker

Electromagnetic release	Tripping characteristic type
	B C
Current I_4 for $0.1 s < t < 45 s$ (for $I_n \leq 32 A$)	$I_4 = 3 I_n$
	$I_4 = 5 I_n$
Current I_5 for $t < 0.1 s$	$I_5 = 5 I_n$ $I_5 = 10 I_n$

t - break time of the circuit breaker

Characteristics I²t

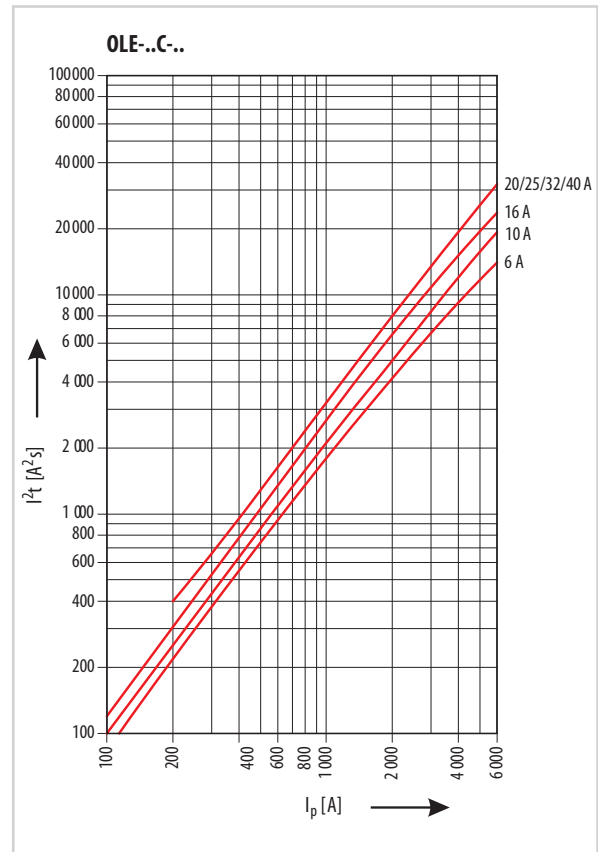
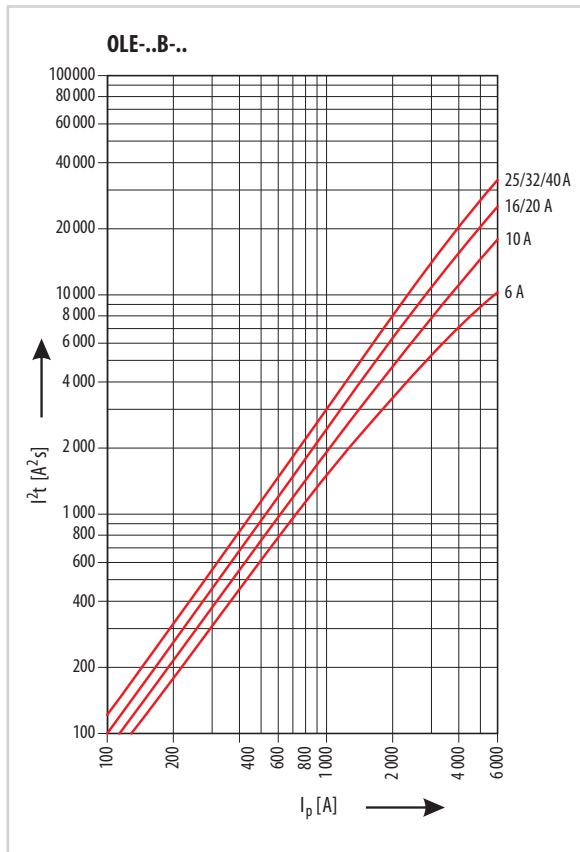

ACCESSORIES



PS-LT-1100

PS-LT-1100-TE

Auxiliary switches

- Accessory to:
 - miniature circuit breakers: LTP, LTK, LTS, LTN, LTN-UC, LVN, LVN-DC
 - residual current circuit breakers: LFN, LFE
 - residual current circuit breakers with overcurrent protection: OLI, OLE (installation on OLI/OLE requires handle adapter OD-OL-NR01 see page B46 except for PS-LT-1100-K)
 - switches: MSO, MSN, AVN-DC.
- For signalling the position of contacts of the device in switching off by releases or manually, i.e. in switching off by overload, short-circuit, shunt trip or undervoltage release, residual current and manually by control lever.
- Mounting on the right side of the device.
- For the number of auxiliary switches connected to the device in combination with the other accessories see page B53, B54.
- Width 9 mm.
- Auxiliary switch function can be checked by test lever on the front side of the device (version PS-...-TE).
- Variant for switching small direct current voltages up to DC 30 V.
- They are suitable for application in SELV and PELV circuits - sufficient insulation is provided between the circuit breaker and the auxiliary switch.

Design	Arrangement of contacts ¹⁾	Type	Order code	Number of modules	Weight [kg]	Package [pcs]
Standard	1100	PS-LT-1100	OEZ:42297	0.5	0.065	1
	2000	PS-LT-2000	OEZ:42299	0.5	0.071	1
	0200	PS-LT-0200	OEZ:42298	0.5	0.065	1
	0010	PS-LT-0010	OEZ:45595	0.5	0.051	1
With test and reset lever	1100	PS-LT-1100-TE	OEZ:42300	0.5	0.054	1
	2000	PS-LT-2000-TE	OEZ:42302	0.5	0.058	1
	0200	PS-LT-0200-TE	OEZ:42301	0.5	0.080	1
For small voltages standard	1100	PS-LT-1100-MN	OEZ:42303	0.5	0.075	1
For small voltages with test lever	1100	PS-LT-1100-MN-TE	OEZ:42304	0.5	0.054	1
With handle adapter OD-OL-NR01 ²⁾	1100	PS-LT-1100-K	OEZ:42305	0.5	0.065	1
Combined with signal contact ³⁾	0011	PS-LT-0011	OEZ:46050	0.5	0.056	1

¹⁾ Each digit indicates successively the number of make, break, auxiliary make-and-break and signal make-and-break contacts.

²⁾ PS-LT-1100-K is a set for convenient ordering in installation on OLI/OLE. The other designs of the auxiliary switches installed on OLI/OLE require separate ordering of OD-OL-NR01.

³⁾ Signal contact: for position signalling of main contacts of the device in switching off by releases, i.e. in switching off by overload, short-circuit, shunt trip and undervoltage release or residual current.

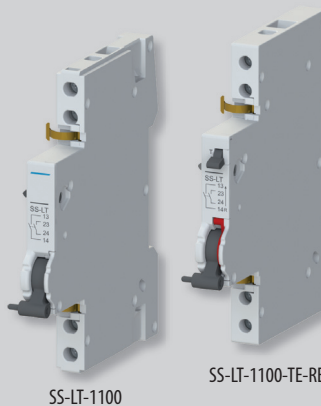

SS-LT-1100

SS-LT-1100-TE-RE

Signal switches

- Accessory to:
 - miniature circuit breakers: LTP, LTK, LTS, LTN, LTN-UC, LVN, LVN-DC
 - residual current circuit breakers: LFN, LFE
 - residual current circuit breakers with overcurrent protection: OLI, OLE (installation on OLI/OLE requires handle adapter OD-OL-NR01 see page B46)
 - switches: MSN.
- For position signalling of main contacts of the device in switching off by releases, i.e. in switching off by overload, short-circuit, shunt trip and undervoltage release or residual current.
- Mounting on the right side of the device.
- For the number of auxiliary switches connected to the device in combination with the other accessories see page B53, B54.
- Auxiliary switch function can be checked by test lever on the front side of the device (version SS-...-TE).
- Signal switch can be reset by means of the red reset lever on the front side of the device without switching the device on by the control lever (version SS-...-RE).
- They are suitable for application in SELV and PELV circuits - sufficient insulation is provided between the circuit breaker and the signal switch.
- Reaction in switching off by releases: in switching off by releases the make/break contact will break/make – for details see the table on page B48.

Design	Arrangement of contacts ¹⁾	Type	Order code	Number of modules	Weight [kg]	Package [pcs]
Standard	11	SS-LT-1100	OEZ:42306	0.5	0.065	1
	20	SS-LT-2000	OEZ:42307	0.5	0.075	1
	02	SS-LT-0200	OEZ:42308	0.5	0.078	1
With test and reset lever	11	SS-LT-1100-TE-RE	OEZ:42309	0.5	0.055	1
	20	SS-LT-2000-TE-RE	OEZ:42310	0.5	0.057	1
	02	SS-LT-0200-TE-RE	OEZ:42311	0.5	0.057	1

¹⁾ Each digit indicates successively the number of make, break, auxiliary make-and-break and signal make-and-break contacts.

ACCESSORIES

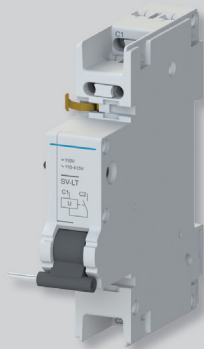

SV-LT-X400

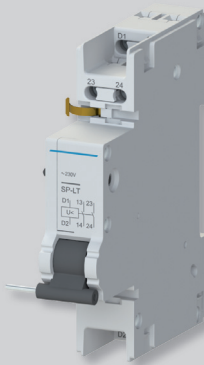

SP-LT-A230

Shunt trips

- Accessory to:
 - miniature circuit breakers: LTS, LTN, LTN-UC, LVN, LVN-DC
 - residual current circuit breakers: LFN, LFE
 - residual current circuit breakers with overcurrent protection: OLI, OLE (installation on OLI/OLE requires handle adapter OD-OL-NR01 see page B46)
 - switches: MSN.
- They are used for device switching off by applied voltage.
- Mounting:
 - on the right side of the device
 - one shunt trip can be connected to one device in combination with the other accessories - see page B54.

Rated voltage U_c	Type	Order code	Number of modules	Weight [kg]	Package [pcs]
AC/DC 24 ÷ 60 V.	SV-LT-X060	OEZ:42312	1	0.106	1
AC 110 ÷ 415 V / DC 110 ÷ 220 V	SV-LT-X400	OEZ:42313	1	0.098	1

Undervoltage releases

- Accessory to:
 - miniature circuit breakers: LTS, LTN, LTN-UC, LVN, LVN-DC
 - residual current circuit breakers: LFN, LFE
 - residual current circuit breakers with overcurrent protection: OLI, OLE (installation on OLI/OLE requires handle adapter OD-OL-NR01 see page B46)
 - switches: MSN.
- They are used for tripping the device at loss of voltage as well as at gradual decrease of voltage.
- They are used for elimination of closing of circuit breaker if voltage is lower than 35 % U_c (switching is possible at voltage higher than 85 % U_c).
- They are often used for protection against device restart following mains failure.
- Mounting:
 - on the right side of the device
 - one undervoltage release can be connected to one device in combination with the other accessories - see page B54.

Rated voltage U_c	Arrangement of contacts ¹⁾	Type	Order code	Number of modules	Weight [kg]	Package [pcs]
AC 230 V	-	SP-LT-A230	OEZ:42315	1	0.109	1
	20	SP-LT-A230-2000	OEZ:42317	1	0.123	1
DC 24 V	-	SP-LT-D024	OEZ:42319	1	0.113	1
	20	SP-LT-D024-2000	OEZ:42321	1	0.117	1
DC 110 V	-	SP-LT-D110	OEZ:42320	1	0.105	1
	20	SP-LT-D110-2000	OEZ:42322	1	0.128	1

¹⁾ Each digit indicates successively the number of make and break contacts.

ACCESSORIES

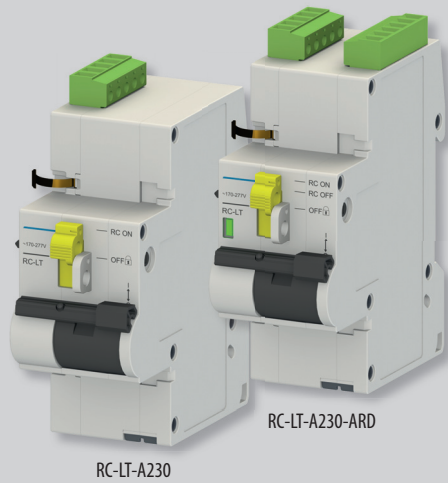

RC-LT-A230

RC-LT-A230-ARD

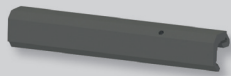

RC-LT-NR01



OD-OL-NR01

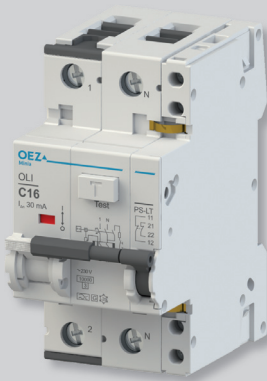

Remote control

- Accessory to:
 - miniature circuit breakers: LTP, LTK, LTS, LTN, LTN-UC
 - residual current circuit breakers: LFE, LFN (only in combination with RC-LT-A230-ARD)
 - residual current circuit breakers with overcurrent protection: OLI, OLE
 - switches: MSO, MSN, AVN-DC.
- They are used for remote switching on/off the device.
- ARD (auto reclose device) function is used for automatic reclosing of the controlled device after switching off by release.
- It is necessary to use a suitable remote control adapter for mounting of a remote control.

Rated voltage U_c	Arrangement of contacts ¹⁾	Type	Order code	Number of modules	Weight [kg]	Package [pcs]
AC 230 V	-	RC-LT-A230	OEZ:46474	2	0.229	1
	0011	RC-LT-A230-ARD	OEZ:46478	2	0.237	1

¹⁾ Each digit indicates successively the number of make, break, auxiliary make-and-break and signal make-and-break contacts.

Remote control adapter

Type	Order code	Description	Weight [kg]	Package [ks]
RC-LT-NR01	OEZ:46480	for 1-pole and 2-pole LTK, LTN, LTN-UC and MSN	0.013	5
RC-LT-NR02	OEZ:46481	for 3-pole and 4-pole LTK, LTN, MSN and AVN-DC	0.011	5
RC-LT-NR03	OEZ:46482	for 2-pole OLE, OLI	0.010	5
RC-LT-NR04	OEZ:46483	for 1-pole and 2-pole LFK, LFN and MSO	0.009	5
RC-LT-NR05	OEZ:46484	for 3-pole and 4-pole LTP, LTK, LTS and MSO	0.011	5

Example of installation

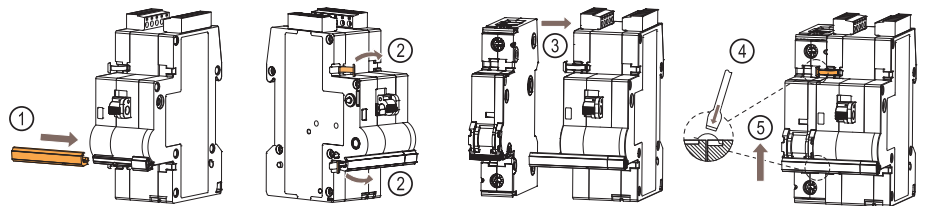

Handle adapter OD-OL-NR01

- Accessory to: OLI, OLE.
- It enables installation of the following accessories on residual current circuit breakers with overcurrent protection OLI, OLE
 - auxiliary switches (PS-LT)
 - signal switches (SS-LT)
 - undervoltage releases (SP-LT)
 - shunt trips (SV-LT).
- Special auxiliary switch PS-LT-1100-K contains the handle adapter OD-OL-NR01. So it is not necessary to order it separately.

Type	Order code	Weight [kg]	Package [pcs]
OD-OL-NR01	OEZ:38270	0.002	5

Example of installation

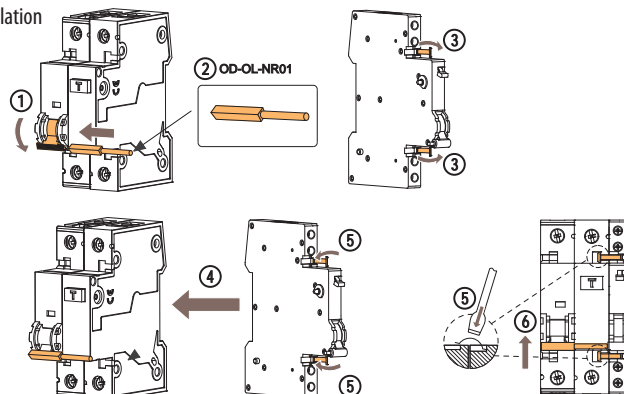

ACCESSORIES



OD-LT-VU01



Locking insert OD-LT-VU01

- Accessory to:
 - miniature circuit breakers: LTK, LTN, LTN-UC, LVN, LVN-DC
 - residual current circuit breakers: OLI, OLE
 - switches: MSN, AVN-DC.
- For safe locking of the control lever in off or on position.
- The protective function of the devices is functional even in locked position.
- Maximum diameter of lock rod - 3 mm.
- The lock is not included in the package.

Type	Order code	Weight [kg]	Package [pcs]
OD-LT-VU01	OEZ:42324	0.012	1



OD-LT-VU02



Locking insert OD-LT-VU02

- Accessory to:
 - miniature circuit breakers: LTP, LTS
 - residual current circuit breakers: LFN, LFE
 - switches: MSO.
- For safe locking of the control lever in off or on position.
- The protective function of the devices is functional even in locked position.
- Maximum diameter of lock rod - 6 mm.
- The lock is not included in the package.
- **In installation it is necessary to press the fixing springs of the insert by two fingers against each other, and then slide them in the holes in the circuit breaker. In case of pressing the insert against the circuit breaker body a part of the plastic cover could break off!**

Type	Order code	Weight [kg]	Package [pcs]
OD-LT-VU02	OEZ:42325	0.003	1



OD-LT-VP01



Sealing insert OD-LT-VP01

- Accessory to:
 - miniature circuit breakers: LTP, LTS, LTN, LTN-UC, LVN, LVN-DC
 - residual current circuit breakers with overcurrent protection: OLI, OLE
 - switches: MSO, MSN, AVN-DC.
- For covering and sealing of terminal screws.

Type	Order code	Weight [kg]	Package [pcs]
OD-LT-VP01	OEZ:42323	0.002	1

ACCESSORIES

Specifications of auxiliary and signal switches

Type		PS-LT SS-LT	PS-LT-1100-MN PS-LT-1100-MN-TE		
Standards		EN 60947-5-1 EN 62019	EN 60947-5-1 EN 62019		
Approval marks					
Arrangement of contacts ¹⁾		1100, 2000, 0200, 0010, 0011	1100, 2000, 0200		
Rated operating voltage/current	U _e /I _e	AC-13	400 V	2 A	-
			230 V	6 A	-
		AC-14	400 V	2 A	-
			230 V	6 A	-
		DC-13 ²⁾	220 V	1 A/0.5 A	-
			110 V	1 A/0.75 A	-
			60 V	3 A/1.5 A	-
		24 V	6 A/3 A	-	
Max. voltage/current		-	DC 30 V / 100 mA		
Min. voltage/current		AC/DC 24 V / 50 mA	DC 5 V / 1 mA		
Backup protection - fuse / miniature circuit breaker		6 A gG / 6 A characteristic B, C	6 A gG / 6 A characteristic B, C		
Mechanical endurance		10 000 operating cycles	10 000 operating cycles		
Electrical endurance at I _e		10 000 operating cycles	10 000 operating cycles		
Degree of protection		IP20	IP20		
Connection					
Cu conductor - rigid (solid, stranded)		0.5 ÷ 2.5 mm ²	0.5 ÷ 2.5 mm ²		
Cu conductor - flexible		0.5 ÷ 2.5 mm ²	0.5 ÷ 2.5 mm ²		
Torque		0.5 Nm	0.5 Nm		
Top or bottom connection		top/bottom	top/bottom		
Operating conditions					
Ambient temperature		-25 ÷ +55 °C	-25 ÷ +55 °C		
Working position		arbitrary	arbitrary		
Climatic resistance according to IEC 60068-2-30		28 operating cycles	28 operating cycles		
Shocks (EN 60068-2-27)		150 m/s ² in 11 ms half-sine pulse	150 m/s ² in 11 ms half-sine pulse		
Vibration resistance according to IEC 60068-2-6		50 m/s ² at 10 ÷ 150 Hz	50 m/s ² at 10 ÷ 150 Hz		

¹⁾ Each digit indicates successively the number of make, break, auxiliary make-and-break and signal make-and-break contacts.

²⁾ Value according to EN 62019 / according to EN 60947-5-1



Function of signal switch SS-LT

Circuit breaker contact state	The state of the MAKE signal contact SS-LT-... *
Initial position - contacts open	switched off
Switching on manually - contacts closed	switched on
Switching off manually - contacts open	switched on
Switching off by release - contacts open	switched off

* The break contact works in opposite way.

ACCESSORIES



Specifications of shunt trips and undervoltage releases

Type		SV-LT	SP-LT
Standards		EN 60947-1	EN 60947-1
Approval marks			
Mounting		on the right side of the device	on the right side of the device
Degree of protection		IP20	IP20
Control circuit coil			
Rated voltage	U_c	AC/DC 24 ÷ 60 V.	AC 230 V
		AC 110 ÷ 415 V / DC 110 ÷ 220 V	DC 24, 110 V
Range of rated voltage		0.7 ÷ 1.1 U_c	0.85 ÷ 1.1 U_c
Voltage range for switching off		-	< 0.35 ÷ 0.7 U_c
Rated frequency	f_n	50/60 Hz	50/60 Hz
Backup protection - fuse / miniature circuit breaker		6 A gG / 6 A characteristic B, C	6 A gG / 6 A characteristic B, C
The length of impulse necessary for device switching off		15 ms	-
Power loss	P		
		AC 230 V -	5 VA
		DC 24 V -	1.4 W
		DC 110 V -	1.8 W
Contact			
Arrangement of contacts ¹⁾		-	20
Min. voltage/current		-	24 V / 50 mA
Backup protection - fuse / miniature circuit breaker		-	6 A gG / 6 A characteristic B, C
Connection			
Cu conductor - rigid (solid, stranded)		0.5 ÷ 2.5 mm ²	0.5 ÷ 2.5 mm ²
Cu conductor - flexible		0.5 ÷ 2.5 mm ²	0.5 ÷ 2.5 mm ²
Torque		0.8 Nm	0.8 Nm
Top or bottom connection		top/bottom	top/bottom
Operating conditions			
Mechanical endurance		10 000 operating cycles	10 000 operating cycles
Electrical endurance		2 000 operating cycles	2 000 operating cycles
Ambient temperature		-25 ÷ +55 °C	-25 ÷ +55 °C
Working position		arbitrary	arbitrary
Climatic resistance according to IEC 60068-2-30		28 operating cycles	28 operating cycles
Shocks (EN 60068-2-27)		50 m/s ² in 11 ms half-sine pulse	50 m/s ² in 11 ms half-sine pulse
Vibration resistance according to IEC 60068-2-6		50 m/s ² at 10 ÷ 150 Hz	50 m/s ² at 10 ÷ 150 Hz

¹⁾ Each digit indicates successively the number of make and break contacts.

ACCESSORIES

Specifications of remote controls

Type		RC-LT-A230	RC-LT-A230-ARD
Standards		EN 50557	EN 50557
Approval marks			
Mounting		on the right side of the device	on the right side of the device
Degree of protection		IP20	IP20
Rated voltage	U_c	AC 230 V	AC 230 V
Range of rated voltage		AC 177 ÷ 270 V	AC 177 ÷ 270 V
Rated frequency	f_n	50/60 Hz	50/60 Hz
Max. length of remote control conductors		1 500 m	1 500 m
Power loss	P	AC 230V 1 VA	-
ARD - auto reclose device			
Number of attempts		0	3
Time after which automatic reclosing will be executed.		-	10 s, 1 min, 10 min
Contact			
Arrangement of contacts ¹⁾		-	0011
Rated operating voltage/current		-	AC 250 V / 2 A
Connection			
Cu conductor - rigid (solid, stranded)		0.5 ÷ 1.5 mm ²	0.5 ÷ 1.5 mm ²
Cu conductor - flexible		0.5 ÷ 1.5 mm ²	0.5 ÷ 1.5 mm ²
Torque		0.25 Nm	0.25 Nm
Operating conditions			
Mechanical endurance		10 000 operating cycles	10 000 operating cycles
Electrical endurance		10 000 operating cycles	10 000 operating cycles
Ambient temperature		-25 ÷ 45 °C	-25 ÷ 45 °C

¹⁾ Each digit indicates successively the number of make, break, auxiliary make-and-break and signal make-and-break contacts.

ACCESSORIES

Dimensions

PS-LT, SS-LT

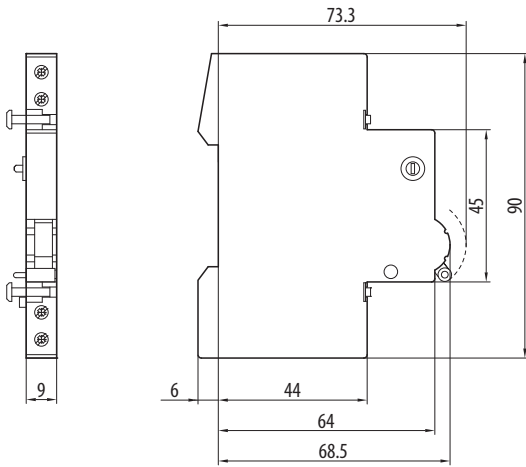

SV-LT

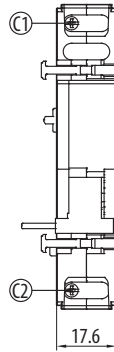

SP-LT

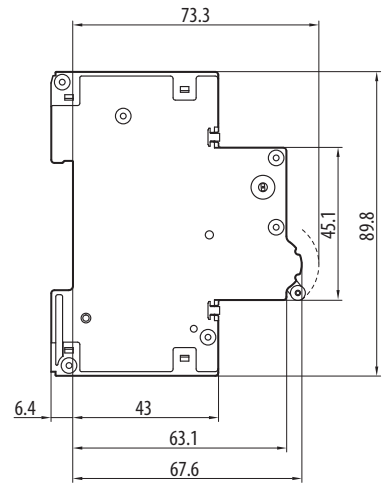
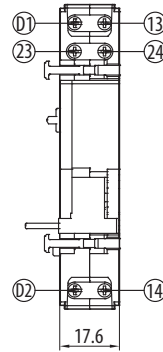

RC-LT

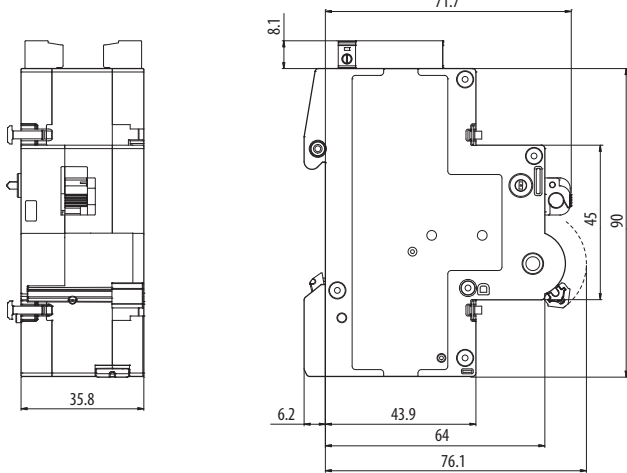

LTK, LTN, LVN, OLI, OLE, MSN, AVN-DC + OD-LT-VU01 + OD-LT-VP01

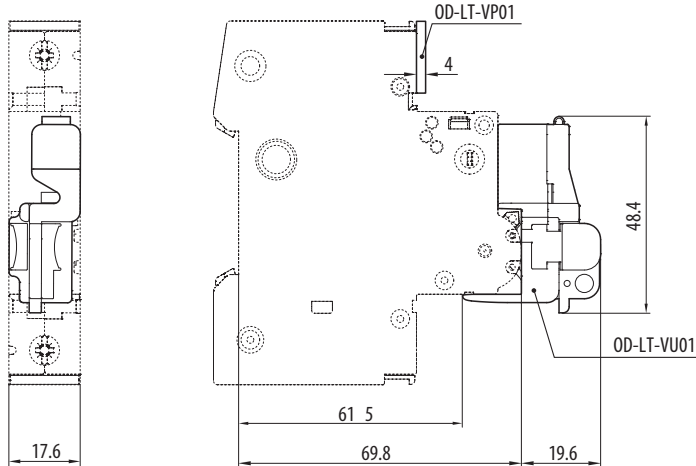

LTP, LTS, LFN, LFE, MSO + OD-LT-VU02

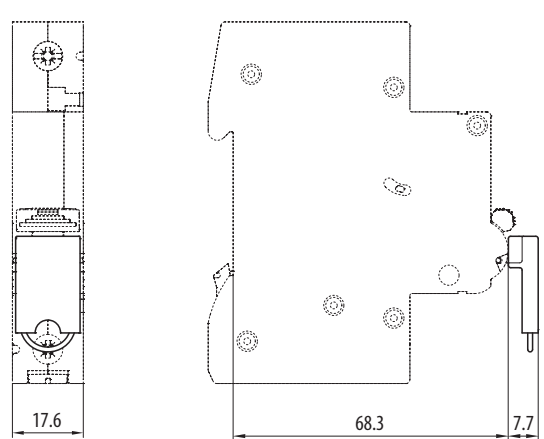

ACCESSORIES

Diagram

Auxiliary switches

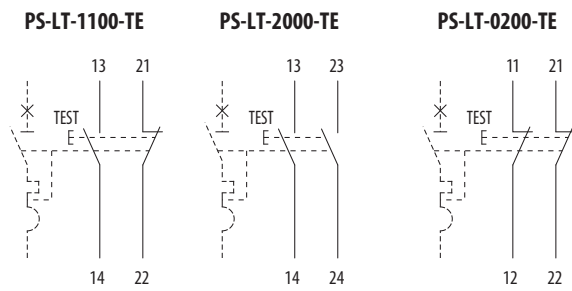
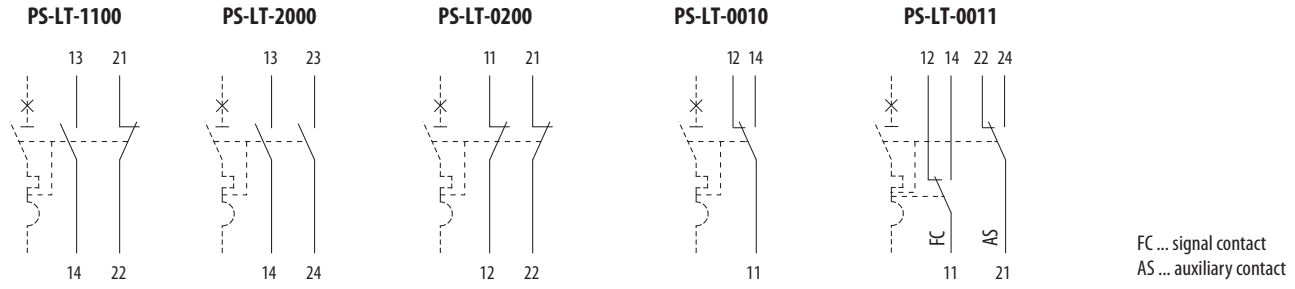

Signal switches

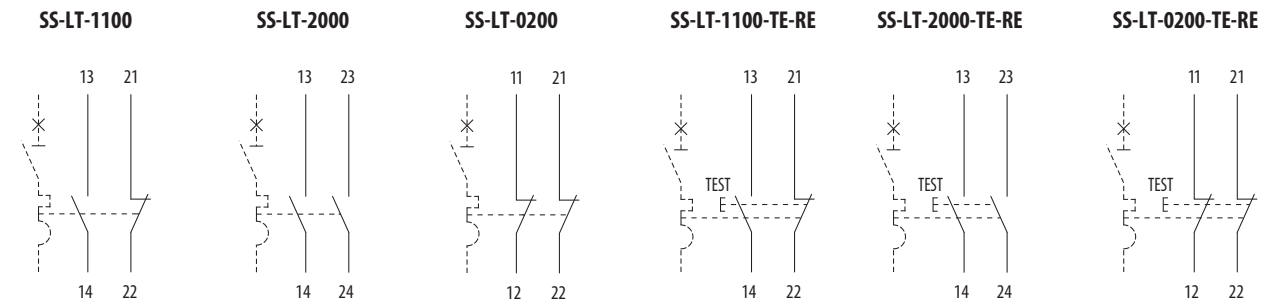

Shunt trips and undervoltage releases

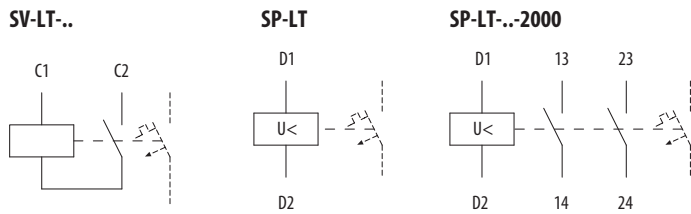

Remote control

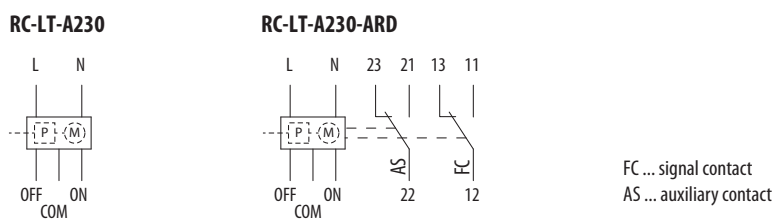

ACCESSORIES

Installation of auxiliary switch, shunt trips or undervoltage releases

For installation of an auxiliary switch, shunt trip or undervoltage releases on a circuit breaker, residual current circuit breaker or switch, the same procedure shall apply as described on the example of installation of the auxiliary switch on the circuit breaker in the following points.

1. In mounting the levers of auxiliary switch and of the circuit breaker are in OFF position.
2. Tilt both fixing springs of the auxiliary switch to the right so that they do not get between the auxiliary switch and circuit breaker in installation.
3. Slide the auxiliary switch onto the circuit breaker from the right.
4. Lock the fixing springs in the circuit breaker body so that the auxiliary switch cannot release.
5. Check correct function by switching.

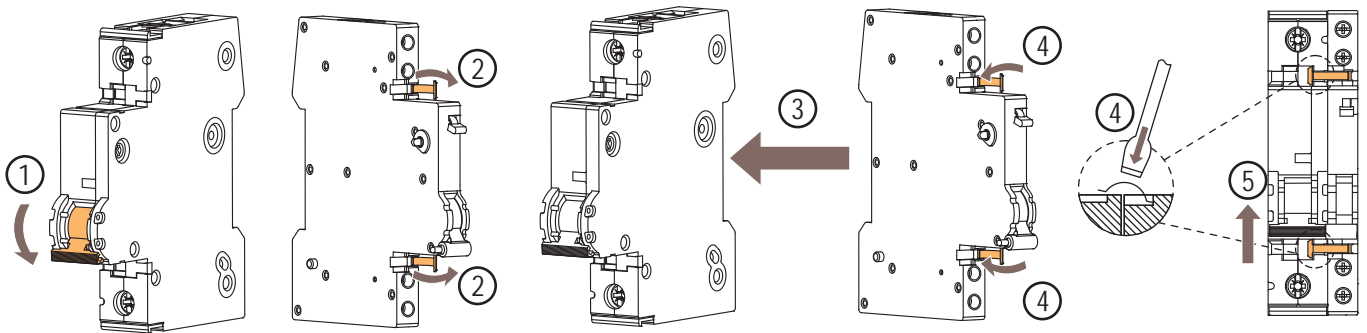

Combination of accessories

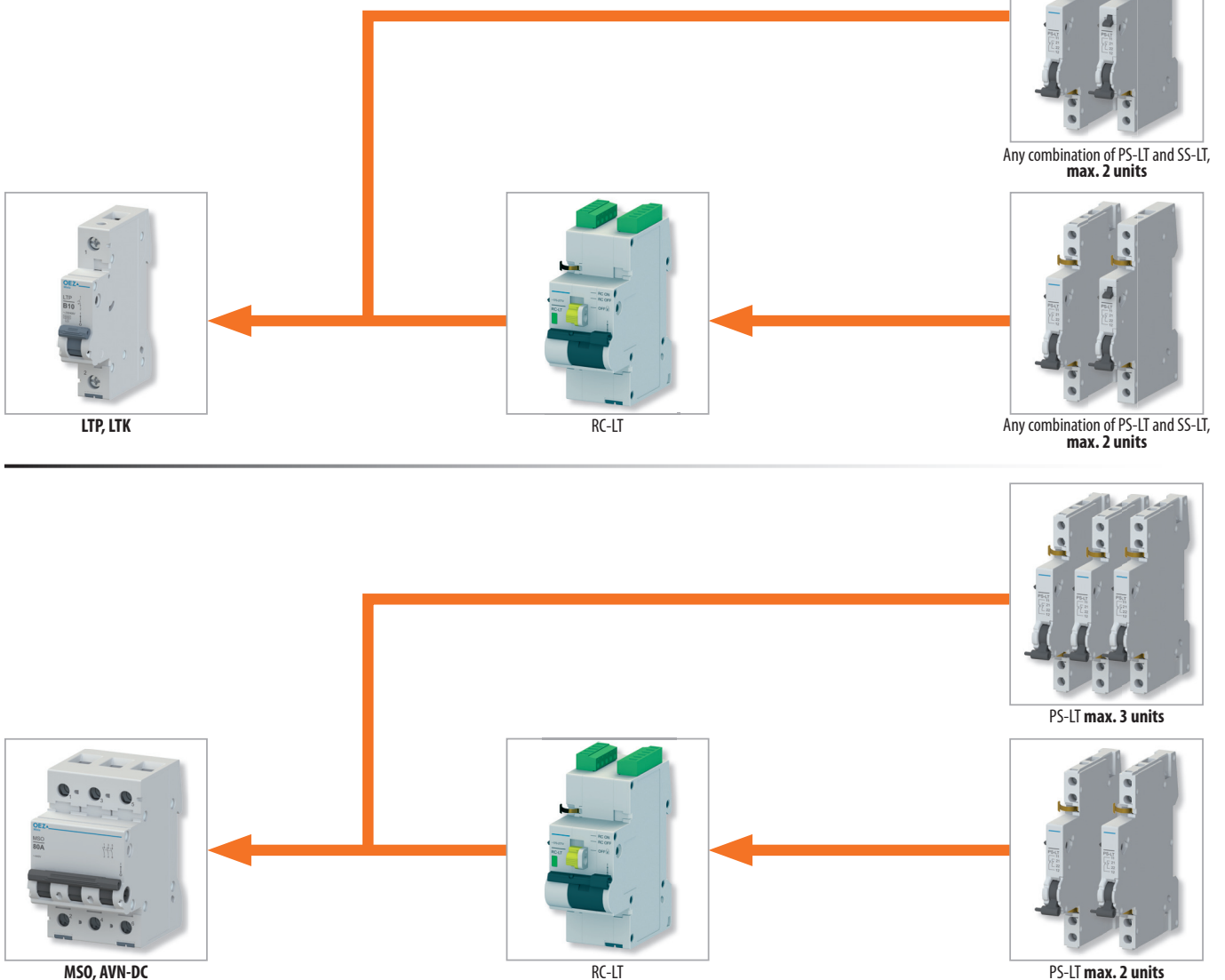

ACCESSORIES

Combination of accessories

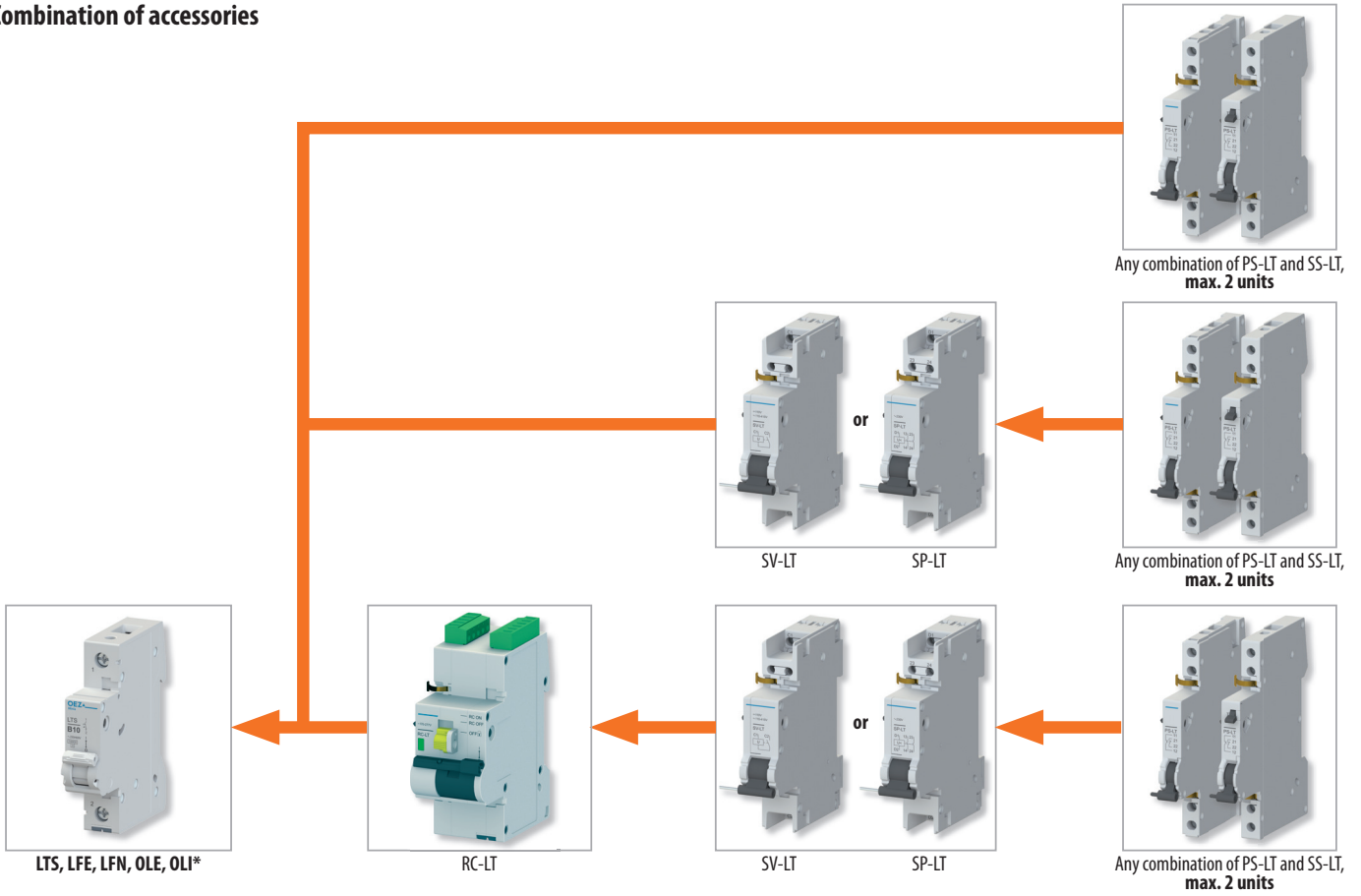

* Installation of accessories on OLE/OLI requires handle adapter OD-OL-NR01, see page B35.

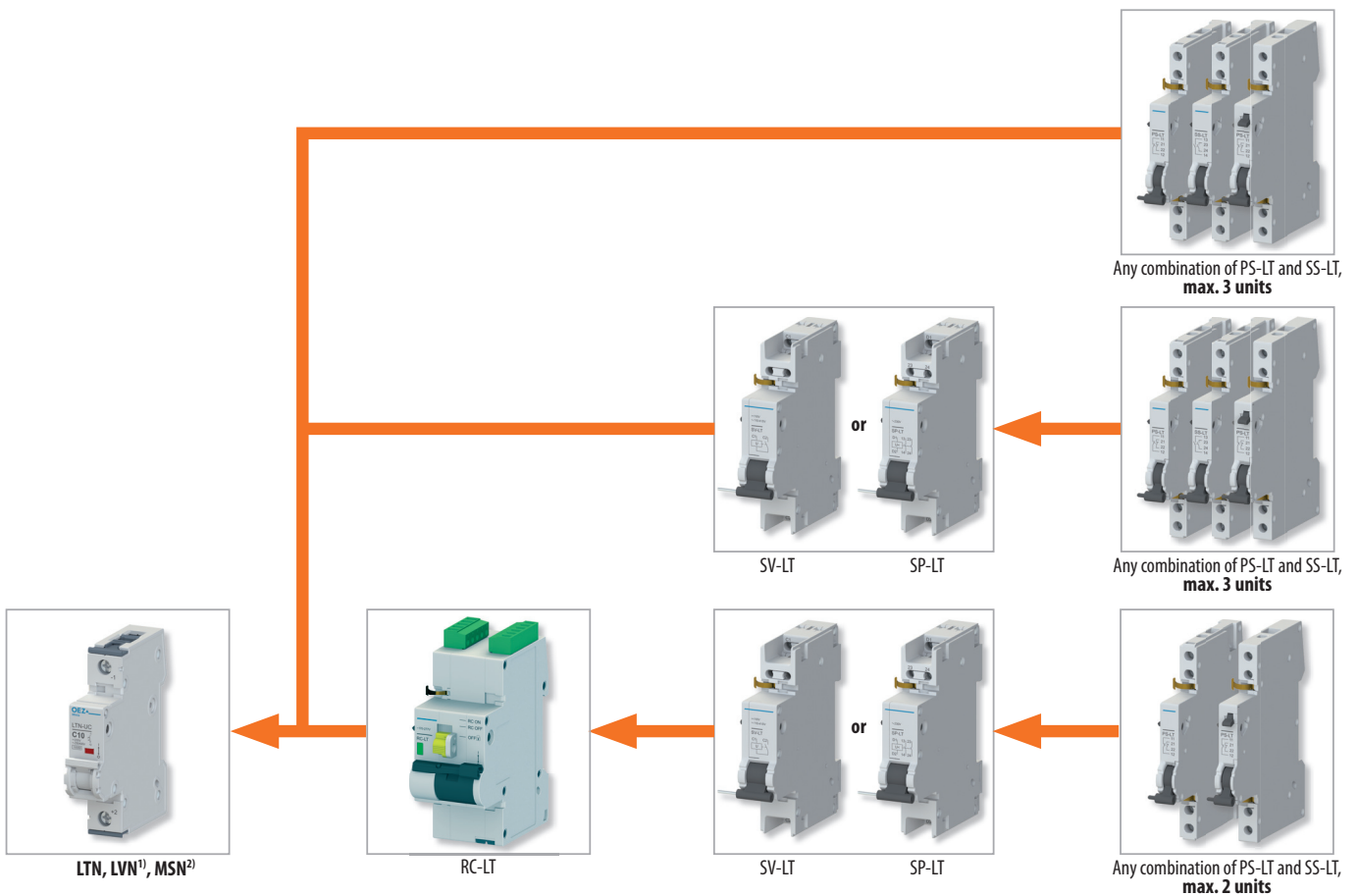

¹⁾ Remote control RC-LT cannot be combined with miniature circuit breaker LVN.

²⁾ Installation of signal switches SS-LT on the MSN, switch, only with SP-LT or SV-LT.

▶ **OEZ s.r.o.**
Šedivská 339
561 51 Letohrad
Czech Republic
tel.: +420 465 672 111
+420 465 672 101
fax: +420 465 672 398
+420 465 672 151
e-mail: oeztrade.cz@oez.com
www.oez.com



Any changes reserved

