

SUMMARY OF MODELS



Type	QA40	QA55
Design	steel-sheet	steel-sheet
Door	plain	plain
Installation	side-by-side	
Place of use	indoor	indoor
Degree of protection (single/double door)	IP40	IP55
Degree of protection against external mechanical impacts	IK10	IK10
Rated values of the used devices	max. 6 300 A, AC 230/400 V	
Protection class	I	

Accessories for switchboard cabinet frame equipment

Base		serves for completion of the cabinet frame: side covers, pedestal, bottom cover
Enclosure		enclosure for assembly of the dimension variant switchboards: corner and transition enclosures, dividing covers, covers for variable depths of cabinets, joining kits
Locks		different variants of locks

Accessories for device fastening

Horizontal mounting grid		for mechanical fastening of heavy devices to the horizontal surface, e.g. Arion circuit breakers
Vertical mounting grid		for mechanical fastening of devices, e.g. Modeion, Varius,...
Mounting plate		for fastening of devices
Modular system		for fastening of modular devices and covering of switchboard after door opening

Accessories for busbar systems fastening

Delta		for constructing of busbar up to 6 300 A (see chapter E2)
Support insulators		for connection of busbar and protective conductor PE (see chapter E7)

DESCRIPTION OF SWICHBOARD CABINETS QA

Cabinet design description

Door

- 1.5 mm thick steel sheet
- sealing from expanded polyurethane for IP55 degree of protection
- screwed perforated reinforcement frame bracing in corners substantially increases door sturdiness
- swivel door handle with double-bar 5mm insert
- left, easily modifiable to right
- earthing points for connection of protective conductor
- single up to width 800 mm
- double door for widths 1 000 and 1 200 mm
- the opening door angle of separately standing cabinets 180°, for cabinets standing in row max. 150°
- outdoor hinges

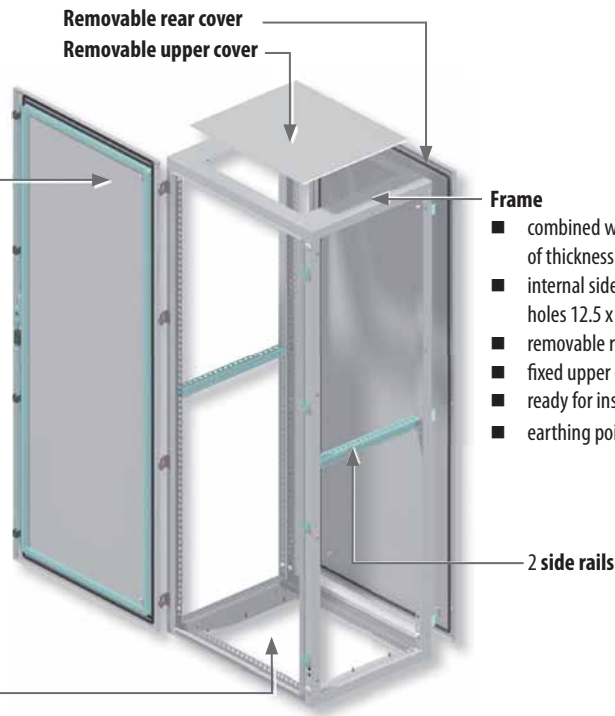

Frame

- combined welded/screwed from bent steel sheet of thickness 2 mm
- internal sides perforated by 25 mm, holes 12.5 x 12.5 mm
- removable rear cover
- fixed upper cover with removable flange
- ready for installation of lifting lugs
- earthing points for connection of protective conductor

Accessories for cabinet completion

Data pocket

Bottom with opening can be covered by sliding covers or one-piece bottom cover
 - to reach IP55, it is necessary to use the one-piece bottom cover

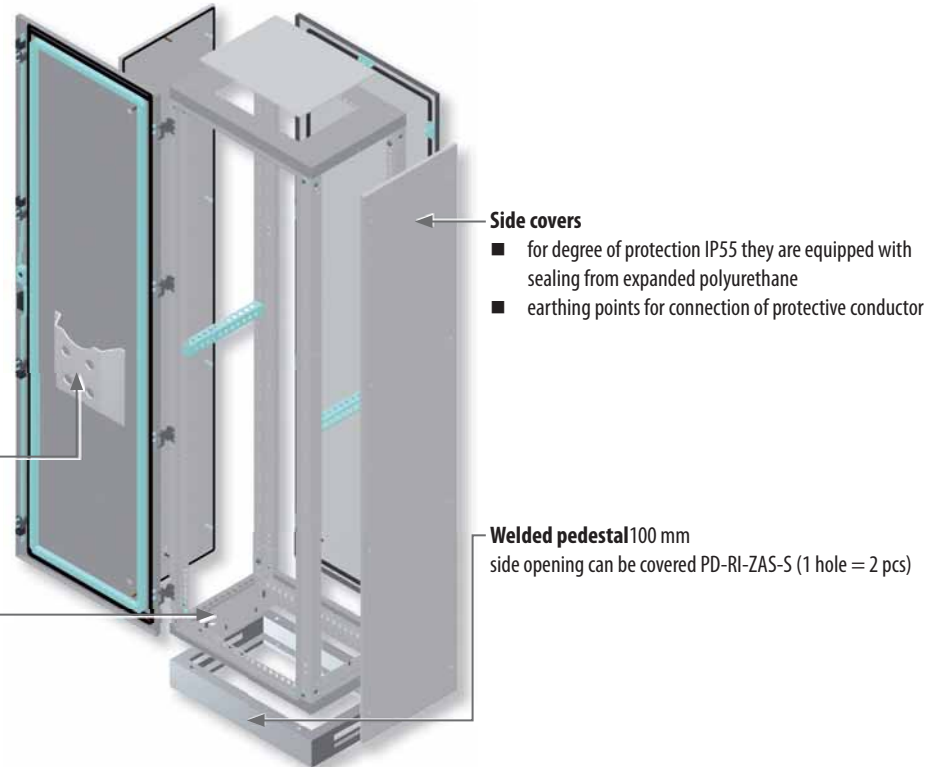

Side covers

- for degree of protection IP55 they are equipped with sealing from expanded polyurethane
- earthing points for connection of protective conductor

Welded pedestal 100 mm

side opening can be covered PD-RI-ZAS-S (1 hole = 2 pcs)

DESCRIPTION OF SWITCHBOARD CABINETS QA

Accessories for fitting of devices

Horizontal mounting grid

- for mechanical fastening of heavy devices to the horizontal surface, e.g. Arion circuit breakers,...
- can be combined with vertical mounting grid, mounting plate and modular system in one cabinet

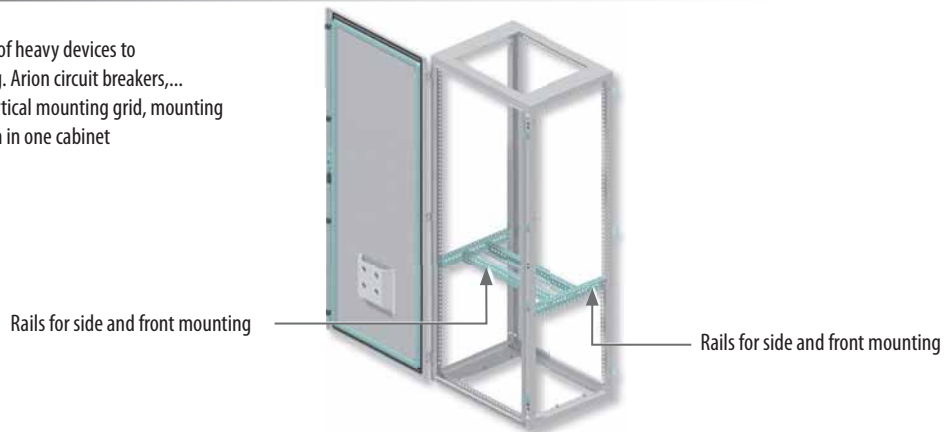

Vertical mounting grid

- for mechanical fastening of devices, e.g. Modeion, Varius, Conteo,...
- can be combined with horizontal mounting grid, mounting plate and modular system in one cabinet

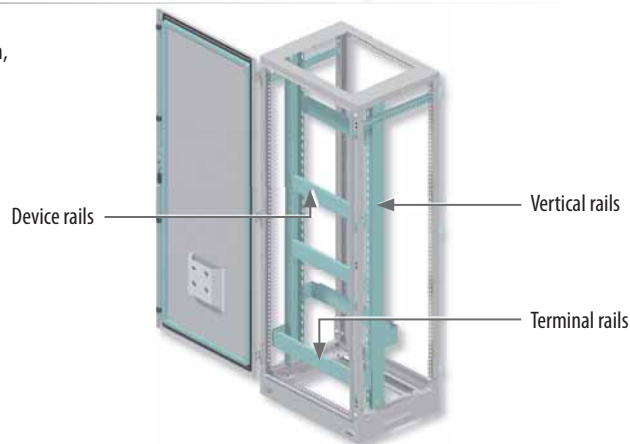

Mounting plate

- for mechanical fastening of small devices, e.g. Minia, Conteo,...
- can be combined with vertical and horizontal mounting grid and modular system in one cabinet

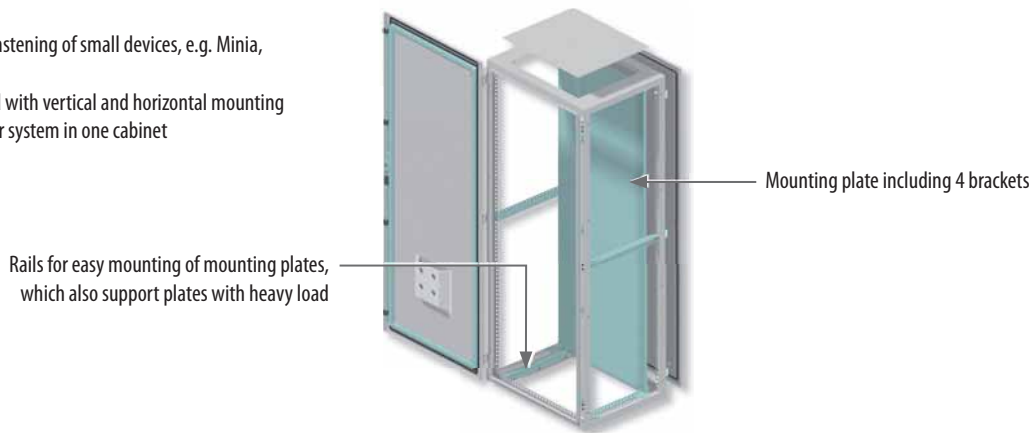

Modular system

- for mechanical fastening of devices, e.g. Minia, Varius, Modeion with option to front cover the whole cabling with front covers
- can be used for covering of cabinets in combination with horizontal and vertical rails as well as with mounting plates

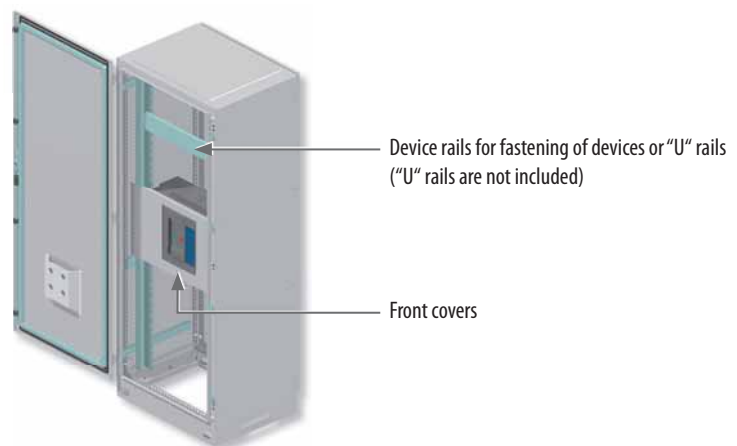

OEZ Configurator can be used for specification of the switchboard cabinets and accessories.

SELECTION TABLE OF SWITCHBOARD CABINETS QA

Frame dimensions			Cabinet IP40		Side covers IP40		Cabinet IP55		Side covers IP55		Pedestals		Mounting plates	
depth [mm]	width [mm]	height [mm]	Type	Order code	Type	Order code	Type	Order code	Type	Order code	Type	Order code	Type	Order code
300	600	1 800	QA40-180603	OEZ:35462	PD-Q12-KB1803	OEZ:35589	QA55-180603	OEZ:35393	PD-Q11-KB1803	OEZ:35571	PD-Q13-PK010603	OEZ:35607	PD-Q03-MP1706	OEZ:17499
		2 000	QA40-200603	OEZ:35485	PD-Q12-KB2003	OEZ:35595	QA55-200603	OEZ:35416	PD-Q11-KB2003	OEZ:35577	PD-Q13-PK010603	OEZ:35607	PD-Q03-MP1906	OEZ:17603
		2 200	QA40-220603	OEZ:35508	PD-Q12-KB2203	OEZ:35601	QA55-220603	OEZ:35439	PD-Q11-KB2203	OEZ:35583	PD-Q13-PK010603	OEZ:35607	PD-Q03-MP2106	OEZ:17607
	800	1 800	QA40-180803	OEZ:35468	PD-Q12-KB1803	OEZ:35589	QA55-180803	OEZ:35399	PD-Q11-KB1803	OEZ:35571	PD-Q13-PK010803	OEZ:35613	PD-Q03-MP1708	OEZ:17500
		2 000	QA40-200803	OEZ:35491	PD-Q12-KB2003	OEZ:35595	QA55-200803	OEZ:35422	PD-Q11-KB2003	OEZ:35577	PD-Q13-PK010803	OEZ:35613	PD-Q03-MP1908	OEZ:17604
		2 200	QA40-220803	OEZ:35514	PD-Q12-KB2203	OEZ:35601	QA55-220803	OEZ:35445	PD-Q11-KB2203	OEZ:35583	PD-Q13-PK010803	OEZ:35613	PD-Q03-MP2108	OEZ:17608
	1 000	1 800	QA40-181003	OEZ:35474	PD-Q12-KB1803	OEZ:35589	QA55-181003	OEZ:35405	PD-Q11-KB1803	OEZ:35571	PD-Q13-PK011003	OEZ:35619	PD-Q03-MP1710	OEZ:17601
		2 000	QA40-201003	OEZ:35497	PD-Q12-KB2003	OEZ:35595	QA55-201003	OEZ:35428	PD-Q11-KB2003	OEZ:35577	PD-Q13-PK011003	OEZ:35619	PD-Q03-MP1910	OEZ:17605
		2 200	QA40-221003	OEZ:35520	PD-Q12-KB2203	OEZ:35601	QA55-221003	OEZ:35451	PD-Q11-KB2203	OEZ:35583	PD-Q13-PK011003	OEZ:35619	PD-Q03-MP2110	OEZ:17609
	1 200	1 800	QA40-181203	OEZ:35480	PD-Q12-KB1803	OEZ:35589	QA55-181203	OEZ:35411	PD-Q11-KB1803	OEZ:35571	PD-Q13-PK011203	OEZ:35625	PD-Q03-MP1712	OEZ:17602
		2 000	QA40-201203	OEZ:35503	PD-Q12-KB2003	OEZ:35595	QA55-201203	OEZ:35434	PD-Q11-KB2003	OEZ:35577	PD-Q13-PK011203	OEZ:35625	PD-Q03-MP1912	OEZ:17606
		2 200	QA40-221203	OEZ:35526	PD-Q12-KB2203	OEZ:35601	QA55-221203	OEZ:35457	PD-Q11-KB2203	OEZ:35583	PD-Q13-PK011203	OEZ:35625	PD-Q03-MP2112	OEZ:21132
400	600	1 800	QA40-180604	OEZ:35463	PD-Q12-KB1804	OEZ:35590	QA55-180604	OEZ:35394	PD-Q11-KB1804	OEZ:35572	PD-Q13-PK010604	OEZ:35608	PD-Q03-MP1706	OEZ:17499
		2 000	QA40-200604	OEZ:35486	PD-Q12-KB2004	OEZ:35596	QA55-200604	OEZ:35417	PD-Q11-KB2004	OEZ:35578	PD-Q13-PK010604	OEZ:35608	PD-Q03-MP1906	OEZ:17603
		2 200	QA40-220604	OEZ:35509	PD-Q12-KB2204	OEZ:35602	QA55-220604	OEZ:35440	PD-Q11-KB2204	OEZ:35584	PD-Q13-PK010604	OEZ:35608	PD-Q03-MP2106	OEZ:17607
	800	1 800	QA40-180804	OEZ:35469	PD-Q12-KB1804	OEZ:35590	QA55-180804	OEZ:35400	PD-Q11-KB1804	OEZ:35572	PD-Q13-PK010804	OEZ:35614	PD-Q03-MP1708	OEZ:17500
		2 000	QA40-200804	OEZ:35492	PD-Q12-KB2004	OEZ:35596	QA55-200804	OEZ:35423	PD-Q11-KB2004	OEZ:35578	PD-Q13-PK010804	OEZ:35614	PD-Q03-MP1908	OEZ:17604
		2 200	QA40-220804	OEZ:35515	PD-Q12-KB2204	OEZ:35602	QA55-220804	OEZ:35446	PD-Q11-KB2204	OEZ:35584	PD-Q13-PK010804	OEZ:35614	PD-Q03-MP2108	OEZ:17608
	1 000	1 800	QA40-181004	OEZ:35475	PD-Q12-KB1804	OEZ:35590	QA55-181004	OEZ:35406	PD-Q11-KB1804	OEZ:35572	PD-Q13-PK011004	OEZ:35620	PD-Q03-MP1710	OEZ:17601
		2 000	QA40-201004	OEZ:35498	PD-Q12-KB2004	OEZ:35596	QA55-201004	OEZ:35429	PD-Q11-KB2004	OEZ:35578	PD-Q13-PK011004	OEZ:35620	PD-Q03-MP1910	OEZ:17605
		2 200	QA40-221004	OEZ:35521	PD-Q12-KB2204	OEZ:35602	QA55-221004	OEZ:35452	PD-Q11-KB2204	OEZ:35584	PD-Q13-PK011004	OEZ:35620	PD-Q03-MP2110	OEZ:17609
	1 200	1 800	QA40-181204	OEZ:35481	PD-Q12-KB1804	OEZ:35590	QA55-181204	OEZ:35412	PD-Q11-KB1804	OEZ:35572	PD-Q13-PK011204	OEZ:35626	PD-Q03-MP1712	OEZ:17602
		2 000	QA40-201204	OEZ:35504	PD-Q12-KB2004	OEZ:35596	QA55-201204	OEZ:35435	PD-Q11-KB2004	OEZ:35578	PD-Q13-PK011204	OEZ:35626	PD-Q03-MP1912	OEZ:17606
		2 200	QA40-221204	OEZ:35527	PD-Q12-KB2204	OEZ:35602	QA55-221204	OEZ:35458	PD-Q11-KB2204	OEZ:35584	PD-Q13-PK011204	OEZ:35626	PD-Q03-MP2112	OEZ:21132
500	600	1 800	QA40-180605	OEZ:35464	PD-Q12-KB1805	OEZ:35591	QA55-180605	OEZ:35395	PD-Q11-KB1805	OEZ:35573	PD-Q13-PK010605	OEZ:35609	PD-Q03-MP1706	OEZ:17499
		2 000	QA40-200605	OEZ:35487	PD-Q12-KB2005	OEZ:35597	QA55-200605	OEZ:35418	PD-Q11-KB2005	OEZ:35579	PD-Q13-PK010605	OEZ:35609	PD-Q03-MP1906	OEZ:17603
		2 200	QA40-220605	OEZ:35510	PD-Q12-KB2205	OEZ:35603	QA55-220605	OEZ:35441	PD-Q11-KB2205	OEZ:35585	PD-Q13-PK010605	OEZ:35609	PD-Q03-MP2106	OEZ:17607
	800	1 800	QA40-180805	OEZ:35470	PD-Q12-KB1805	OEZ:35591	QA55-180805	OEZ:35401	PD-Q11-KB1805	OEZ:35573	PD-Q13-PK010805	OEZ:35615	PD-Q03-MP1708	OEZ:17500
		2 000	QA40-200805	OEZ:35493	PD-Q12-KB2005	OEZ:35597	QA55-200805	OEZ:35424	PD-Q11-KB2005	OEZ:35579	PD-Q13-PK010805	OEZ:35615	PD-Q03-MP1908	OEZ:17604
		2 200	QA40-220805	OEZ:35516	PD-Q12-KB2205	OEZ:35603	QA55-220805	OEZ:35447	PD-Q11-KB2205	OEZ:35585	PD-Q13-PK010805	OEZ:35615	PD-Q03-MP2108	OEZ:17608
	1 000	1 800	QA40-181005	OEZ:35476	PD-Q12-KB1805	OEZ:35591	QA55-181005	OEZ:35407	PD-Q11-KB1805	OEZ:35573	PD-Q13-PK011005	OEZ:35621	PD-Q03-MP1710	OEZ:17601
		2 000	QA40-201005	OEZ:35499	PD-Q12-KB2005	OEZ:35597	QA55-201005	OEZ:35430	PD-Q11-KB2005	OEZ:35579	PD-Q13-PK011005	OEZ:35621	PD-Q03-MP1910	OEZ:17605
		2 200	QA40-221005	OEZ:35522	PD-Q12-KB2205	OEZ:35603	QA55-221005	OEZ:35453	PD-Q11-KB2205	OEZ:35585	PD-Q13-PK011005	OEZ:35621	PD-Q03-MP2110	OEZ:17609
	1 200	1 800	QA40-181205	OEZ:35482	PD-Q12-KB1805	OEZ:35591	QA55-181205	OEZ:35413	PD-Q11-KB1805	OEZ:35573	PD-Q13-PK011205	OEZ:35627	PD-Q03-MP1712	OEZ:17602
		2 000	QA40-201205	OEZ:35505	PD-Q12-KB2005	OEZ:35597	QA55-201205	OEZ:35436	PD-Q11-KB2005	OEZ:35579	PD-Q13-PK011205	OEZ:35627	PD-Q03-MP1912	OEZ:17606
		2 200	QA40-221205	OEZ:35528	PD-Q12-KB2205	OEZ:35603	QA55-221205	OEZ:35459	PD-Q11-KB2205	OEZ:35585	PD-Q13-PK011205	OEZ:35627	PD-Q03-MP2112	OEZ:21132
600	600	1 800	QA40-180606	OEZ:35465	PD-Q12-KB1806	OEZ:35592	QA55-180606	OEZ:35396	PD-Q11-KB1806	OEZ:35574	PD-Q13-PK010606	OEZ:35610	PD-Q03-MP1706	OEZ:17499
		2 000	QA40-200606	OEZ:35488	PD-Q12-KB2006	OEZ:35598	QA55-200606	OEZ:35419	PD-Q11-KB2006	OEZ:35580	PD-Q13-PK010606	OEZ:35610	PD-Q03-MP1906	OEZ:17603
		2 200	QA40-220606	OEZ:35511	PD-Q12-KB2206	OEZ:35604	QA55-220606	OEZ:35442	PD-Q11-KB2206	OEZ:35586	PD-Q13-PK010606	OEZ:35610	PD-Q03-MP2106	OEZ:17607
	800	1 800	QA40-180806	OEZ:35471	PD-Q12-KB1806	OEZ:35592	QA55-180806	OEZ:35402	PD-Q11-KB1806	OEZ:35574	PD-Q13-PK010806	OEZ:35616	PD-Q03-MP1708	OEZ:17500
		2 000	QA40-200806	OEZ:35494	PD-Q12-KB2006	OEZ:35598	QA55-200806	OEZ:35425	PD-Q11-KB2006	OEZ:35580	PD-Q13-PK010806	OEZ:35616	PD-Q03-MP1908	OEZ:17604
		2 200	QA40-220806	OEZ:35517	PD-Q12-KB2206	OEZ:35604	QA55-220806	OEZ:35448	PD-Q11-KB2206	OEZ:35586	PD-Q13-PK010806	OEZ:35616	PD-Q03-MP2108	OEZ:17608
	1 000	1 800	QA40-181006	OEZ:35477	PD-Q12-KB1806	OEZ:35592	QA55-181006	OEZ:35408	PD-Q11-KB1806	OEZ:35574	PD-Q13-PK011006	OEZ:35622	PD-Q03-MP1710	OEZ:17601
		2 000	QA40-201006	OEZ:35500	PD-Q12-KB2006	OEZ:35598	QA55-201006	OEZ:35431	PD-Q11-KB2006	OEZ:35580	PD-Q13-PK011006	OEZ:35622	PD-Q03-MP1910	OEZ:17605
		2 200	QA40-221006	OEZ:35523	PD-Q12-KB2206	OEZ:35604	QA55-221006	OEZ:35454	PD-Q11-KB2206	OEZ:35586	PD-Q13-PK011006	OEZ:35622	PD-Q03-MP2110	OEZ:17609
	1 200	1 800	QA40-181206	OEZ:35483	PD-Q12-KB1806	OEZ:35592	QA55-181206	OEZ:35414	PD-Q11-KB1806	OEZ:35574	PD-Q13-PK011206	OEZ:35628	PD-Q03-MP1712	OEZ:17602
		2 000	QA40-201206	OEZ:35506	PD-Q12-KB2006	OEZ:35598	QA55-201206	OEZ:35437	PD-Q11-KB2006	OEZ:35580	PD-Q13-PK011206	OEZ:35628	PD-Q03-MP1912	OEZ:17606
		2 200	QA40-221206	OEZ:35529	PD-Q12-KB2206	OEZ:35604	QA55-221206	OEZ:35460	PD-Q11-KB2206	OEZ:35586	PD-Q13-PK011206	OEZ:35628	PD-Q03-MP2112	OEZ:21132
800	600	1 800	QA40-180608	OEZ:35466	PD-Q12-KB1808	OEZ:35593	QA55-180608	OEZ:35397	PD-Q11-KB1808	OEZ:35575	PD-Q13-PK010608	OEZ:35611	PD-Q03-MP1706	OEZ:17499
		2 000	QA40-200608	OEZ:35489	PD-Q12-KB2008	OEZ:35599	QA55-200608	OEZ:35420	PD-Q11-KB2008	OEZ:35581	PD-Q13-PK010608	OEZ:35611	PD-Q03-MP1906	OEZ:17603
		2 200	QA40-220608	OEZ:35512	PD-Q12-KB2208	OEZ:35605	QA55-220608	OEZ:35443	PD-Q11-KB2208	OEZ:35587	PD-Q13-PK010608	OEZ:35611	PD-Q03-MP2106	OEZ:17607
	800	1 800	QA40-180808	OEZ:35472	PD-Q12-KB1808	OEZ:35593	QA55-180808	OEZ:35403	PD-Q11-KB1808	OEZ:35575	PD-Q13-PK010808	OEZ:35617	PD-Q03-MP1708	OEZ:17500
		2 000	QA40-200808	OEZ:35495	PD-Q12-KB2008	OEZ:35599	QA55-200808	OEZ:35426	PD-Q11-KB2008	OEZ:35581	PD-Q13-PK010808	OEZ:35617	PD-Q03-MP1908	OEZ:17604
		2 200	QA40-220808	OEZ:35518	PD-Q12-KB2208	OEZ:35605	QA55-220808	OEZ:35449	PD-Q11-KB2208	OEZ:35587	PD-Q13-PK010808	OEZ:35617	PD-Q03-MP2108	OEZ:17608
	1 000	1 800	QA40-181008	OEZ:35478	PD-Q12-KB1808	OEZ:35593	QA55-181008	OEZ:35409	PD-Q11-KB1808	OEZ:35575	PD-Q13-PK011008	OEZ:35623	PD-Q03-MP1710	OEZ:17601
		2 000	QA40-201008	OEZ:35501	PD-Q12-KB2008	OEZ:35599	QA55-201008	OEZ:35432	PD-Q11-KB2008	OEZ:35581	PD-Q13-PK011008	OEZ:35623	PD-Q03-MP1910	OEZ:17605
		2 200	QA40-221008	OEZ:35524	PD-Q12-KB2208	OEZ:35605	QA55-221008	OEZ:35455	PD-Q11-KB2208	OEZ:35587	PD-Q13-PK011008	OEZ:35623	PD-Q03-MP2110	OEZ:17609
	1 200	1 800	QA40-181208	OEZ:35484	PD-Q12-KB1808	OEZ:35593	QA55-181208	OEZ:35415	PD-Q11-KB1808	OEZ:35575	PD-Q13-PK011208	OEZ:35629	PD-Q03-MP1712	OEZ:17602

SIDE-BY-SIDE CABINETS QA



QA55-200808

Basic description

- For static load up to 600 kg.
- Sturdy construction.
- For circuits with rated current up to 6 300 A.
- Degree of protection IP40 and IP55.
- To reach IP55 degree of protection, it is necessary to use the one-piece bottom cover (accessories).
- Thermoreactive epoxy-polyester powder coating RAL 7035.
- For widths of 1 000 and 1 200 mm of double door.
- Flexible configuration of the cabinet interior for a choice of mounting plate or rack-mounting systems, allowing assemblies from various types of rails.

Selection table

Frame dimensions [mm]			Cabinet IP40		Cabinet IP55		Weight [kg]
depth	width	height	Type	Order code	Type	Order code	
300	600	1 800	QA40-180603	OEZ:35462	QA55-180603	OEZ:35393	66
		2 000	QA40-200603	OEZ:35485	QA55-200603	OEZ:35416	71
		2 200	QA40-220603	OEZ:35508	QA55-220603	OEZ:35439	77
	800	1 800	QA40-180803	OEZ:35468	QA55-180803	OEZ:35399	80
		2 000	QA40-200803	OEZ:35491	QA55-200803	OEZ:35422	85
		2 200	QA40-220803	OEZ:35514	QA55-220803	OEZ:35445	91
	1 000	1 800	QA40-181003	OEZ:35474	QA55-181003	OEZ:35405	94
		2 000	QA40-201003	OEZ:35497	QA55-201003	OEZ:35428	100
		2 200	QA40-221003	OEZ:35520	QA55-221003	OEZ:35451	105
	1 200	1 800	QA40-181203	OEZ:35480	QA55-181203	OEZ:35411	108
		2 000	QA40-201203	OEZ:35503	QA55-201203	OEZ:35434	114
		2 200	QA40-221203	OEZ:35526	QA55-221203	OEZ:35457	119
400	600	1 800	QA40-180604	OEZ:35463	QA55-180604	OEZ:35394	68
		2 000	QA40-200604	OEZ:35486	QA55-200604	OEZ:35417	74
		2 200	QA40-220604	OEZ:35509	QA55-220604	OEZ:35440	79
	800	1 800	QA40-180804	OEZ:35469	QA55-180804	OEZ:35400	87
		2 000	QA40-200804	OEZ:35492	QA55-200804	OEZ:35423	89
		2 200	QA40-220804	OEZ:35515	QA55-220804	OEZ:35446	94
	1 000	1 800	QA40-181004	OEZ:35475	QA55-181004	OEZ:35406	98
		2 000	QA40-201004	OEZ:35498	QA55-201004	OEZ:35429	103
		2 200	QA40-221004	OEZ:35521	QA55-221004	OEZ:35452	109
	1 200	1 800	QA40-181204	OEZ:35481	QA55-181204	OEZ:35412	112
		2 000	QA40-201204	OEZ:35504	QA55-201204	OEZ:35435	118
		2 200	QA40-221204	OEZ:35527	QA55-221204	OEZ:35458	124
500	600	1 800	QA40-180605	OEZ:35464	QA55-180605	OEZ:35395	70
		2 000	QA40-200605	OEZ:35487	QA55-200605	OEZ:35418	76
		2 200	QA40-220605	OEZ:35510	QA55-220605	OEZ:35441	81
	800	1 800	QA40-180805	OEZ:35470	QA55-180805	OEZ:35401	90
		2 000	QA40-200805	OEZ:35493	QA55-200805	OEZ:35424	92
		2 200	QA40-220805	OEZ:35516	QA55-220805	OEZ:35447	98
	1 000	1 800	QA40-181005	OEZ:35476	QA55-181005	OEZ:35407	102
		2 000	QA40-201005	OEZ:35499	QA55-201005	OEZ:35430	107
		2 200	QA40-221005	OEZ:35522	QA55-221005	OEZ:35453	113
	1 200	1 800	QA40-181205	OEZ:35482	QA55-181205	OEZ:35413	117
		2 000	QA40-201205	OEZ:35505	QA55-201205	OEZ:35436	122
		2 200	QA40-221205	OEZ:35528	QA55-221205	OEZ:35459	128
600	600	1 800	QA40-180606	OEZ:35465	QA55-180606	OEZ:35396	73
		2 000	QA40-200606	OEZ:35488	QA55-200606	OEZ:35419	78
		2 200	QA40-220606	OEZ:35511	QA55-220606	OEZ:35442	84
	800	1 800	QA40-180806	OEZ:35471	QA55-180806	OEZ:35402	93
		2 000	QA40-200806	OEZ:35494	QA55-200806	OEZ:35425	96
		2 200	QA40-220806	OEZ:35517	QA55-220806	OEZ:35448	101
	1 000	1 800	QA40-181006	OEZ:35477	QA55-181006	OEZ:35408	105
		2 000	QA40-201006	OEZ:35500	QA55-201006	OEZ:35431	111
		2 200	QA40-221006	OEZ:35523	QA55-221006	OEZ:35454	116
	1 200	1 800	QA40-181206	OEZ:35483	QA55-181206	OEZ:35414	121
		2 000	QA40-201206	OEZ:35506	QA55-201206	OEZ:35437	126
		2 200	QA40-221206	OEZ:35529	QA55-221206	OEZ:35460	132
800	600	1 800	QA40-180608	OEZ:35466	QA55-180608	OEZ:35397	77
		2 000	QA40-200608	OEZ:35489	QA55-200608	OEZ:35420	83
		2 200	QA40-220608	OEZ:35512	QA55-220608	OEZ:35443	88
	800	1 800	QA40-180808	OEZ:35472	QA55-180808	OEZ:35403	100
		2 000	QA40-200808	OEZ:35495	QA55-200808	OEZ:35426	102
		2 200	QA40-220808	OEZ:35518	QA55-220808	OEZ:35449	108
	1 000	1 800	QA40-181008	OEZ:35478	QA55-181008	OEZ:35409	112
		2 000	QA40-201008	OEZ:35501	QA55-201008	OEZ:35432	118
		2 200	QA40-221008	OEZ:35524	QA55-221008	OEZ:35455	124
	1 200	1 800	QA40-181208	OEZ:35484	QA55-181208	OEZ:35415	129
		2 000	QA40-201208	OEZ:35507	QA55-201208	OEZ:35438	135
		2 200	QA40-221208	OEZ:35530	QA55-221208	OEZ:35461	140
1 000	600	1 800	QA40-180610	OEZ:35467	QA55-180610	OEZ:35398	83
		2 000	QA40-200610	OEZ:35490	QA55-200610	OEZ:35421	87
		2 200	QA40-220610	OEZ:35513	QA55-220610	OEZ:35444	93
	800	1 800	QA40-180810	OEZ:35473	QA55-180810	OEZ:35404	107
		2 000	QA40-200810	OEZ:35496	QA55-200810	OEZ:35427	109
		2 200	QA40-220810	OEZ:35519	QA55-220810	OEZ:35450	114
	1 000	1 800	QA40-181010	OEZ:35479	QA55-181010	OEZ:35410	119
		2 000	QA40-201010	OEZ:35502	QA55-201010	OEZ:35433	126
		2 200	QA40-221010	OEZ:35525	QA55-221010	OEZ:35456	132

Basic design of the cabinet contains:

- frame
 - removable upper cover
 - removable rear cover
 - opening in bottom
 - 2 side rails
- door
 - swivel door handle
 - double-bar 5mm insert, key
 - screwed perforated reinforcement frame around entire door periphery with bracing in corners
 - door opening angle 180°
 - outdoor hinges

SIDE-BY-SIDE CABINETS QA



1K
single door design



2D
two doors design

QA switchboard cabinets 1 000 mm width with single door

Frame dimensions [mm]			Degree of protection IP40		Degree of protection IP55		Weight [kg]
depth	width	height	Type	Order code	Type	Order code	
300	1 000	1 800	QA40-181003-1K	OEZ:37064	QA55-181003-1K	OEZ:37100	94
		2 000	QA40-201003-1K	OEZ:37076	QA55-201003-1K	OEZ:37112	100
		2 200	QA40-221003-1K	OEZ:37088	QA55-221003-1K	OEZ:37124	105
400	1 000	1 800	QA40-181004-1K	OEZ:37065	QA55-181004-1K	OEZ:37101	98
		2 000	QA40-201004-1K	OEZ:37077	QA55-201004-1K	OEZ:37113	103
		2 200	QA40-221004-1K	OEZ:37089	QA55-221004-1K	OEZ:37125	109
500	1 000	1 800	QA40-181005-1K	OEZ:37066	QA55-181005-1K	OEZ:37102	101
		2 000	QA40-201005-1K	OEZ:37078	QA55-201005-1K	OEZ:37114	107
		2 200	QA40-221005-1K	OEZ:37090	QA55-221005-1K	OEZ:37126	113
600	1 000	1 800	QA40-181006-1K	OEZ:37067	QA55-181006-1K	OEZ:37103	105
		2 000	QA40-201006-1K	OEZ:37079	QA55-201006-1K	OEZ:37115	111
		2 200	QA40-221006-1K	OEZ:37091	QA55-221006-1K	OEZ:37127	116
800	1 000	1 800	QA40-181008-1K	OEZ:37068	QA55-181008-1K	OEZ:37104	112
		2 000	QA40-201008-1K	OEZ:37080	QA55-201008-1K	OEZ:37116	118
		2 200	QA40-221008-1K	OEZ:37092	QA55-221008-1K	OEZ:37128	124
1 000	1 000	1 800	QA40-181010-1K	OEZ:37069	QA55-181010-1K	OEZ:37105	119
		2 000	QA40-201010-1K	OEZ:37081	QA55-201010-1K	OEZ:37117	126
		2 200	QA40-221010-1K	OEZ:37093	QA55-221010-1K	OEZ:37129	132

Door both front and rear

Frame dimensions [mm]			Degree of protection IP40		Degree of protection IP55		Weight [kg]
depth	width	height	Type	Order code	Type	Order code	
600		1 800	QA40-180608-2D	OEZ:35727	QA55-180608-2D	OEZ:35706	77
		2 000	QA40-200608-2D	OEZ:35734	QA55-200608-2D	OEZ:35713	83
		2 200	QA40-220608-2D	OEZ:35741	QA55-220608-2D	OEZ:35720	88
800		1 800	QA40-180808-2D	OEZ:35729	QA55-180808-2D	OEZ:35708	100
		2 000	QA40-200808-2D	OEZ:35736	QA55-200808-2D	OEZ:35715	102
		2 200	QA40-220808-2D	OEZ:35743	QA55-220808-2D	OEZ:35722	108
1 000		1 800	QA40-181008-2D	OEZ:35731	QA55-181008-2D	OEZ:35710	112
		2 000	QA40-201008-2D	OEZ:35738	QA55-201008-2D	OEZ:35717	118
		2 200	QA40-221008-2D	OEZ:35745	QA55-221008-2D	OEZ:35724	124
1 200		1 800	QA40-181208-2D	OEZ:35733	QA55-181208-2D	OEZ:35712	129
		2 000	QA40-201208-2D	OEZ:35740	QA55-201208-2D	OEZ:35719	135
		2 200	QA40-221208-2D	OEZ:35747	QA55-221208-2D	OEZ:35726	140
600		1 800	QA40-180610-2D	OEZ:35728	QA55-180610-2D	OEZ:35707	83
		2 000	QA40-200610-2D	OEZ:35735	QA55-200610-2D	OEZ:35714	87
		2 200	QA40-220610-2D	OEZ:35742	QA55-220610-2D	OEZ:35721	93
1 000	800	1 800	QA40-180810-2D	OEZ:35730	QA55-180810-2D	OEZ:35709	107
		2 000	QA40-200810-2D	OEZ:35737	QA55-200810-2D	OEZ:35716	109
		2 200	QA40-220810-2D	OEZ:35744	QA55-220810-2D	OEZ:35723	114
1 000	1 000	1 800	QA40-181010-2D	OEZ:35732	QA55-181010-2D	OEZ:35711	119
		2 000	QA40-201010-2D	OEZ:35739	QA55-201010-2D	OEZ:35718	126
		2 200	QA40-221010-2D	OEZ:35746	QA55-221010-2D	OEZ:35725	132

SIDE-BY-SIDE CABINETS QA

Specifications

Type	QA40	QA55
Standards	IEC 62208 EN 62208	IEC 62208 EN 62208
Approval marks		
Installation	side-by-side (separately standing)	side-by-side (separately standing)
Degree of protection	IP40	IP55
Rated values of the used devices	max. 6 300 A, AC 230/400 V	max. 6 300 A, AC 230/400 V
Degree of protection against external mechanical impacts	plain door IK10	IK10
Protection class	I	I
Use	indoor	indoor
Cabinet material		
For indoor use	steel sheet coated with epoxy-polyester powder paint, gloss	steel sheet coated with epoxy-polyester powder paint, gloss
Sealing	-	expanded polyurethane
Door		
Opening	right/left	right/left
Door	single/double	single/double
Design	plain	plain

Type designation

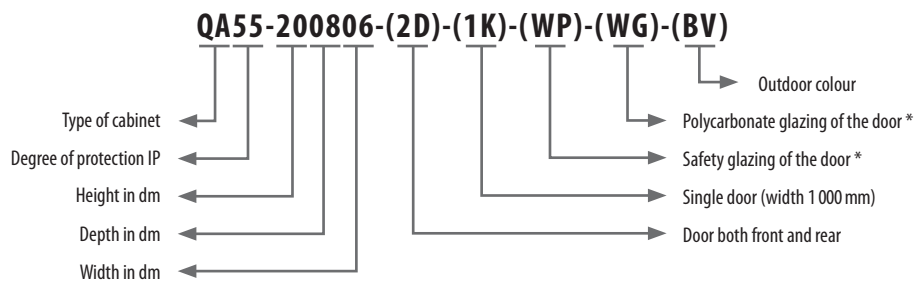

* Note: max. size of door glazing is by 300 mm smaller than the nominal width (height) of the cabinet.

Accessories

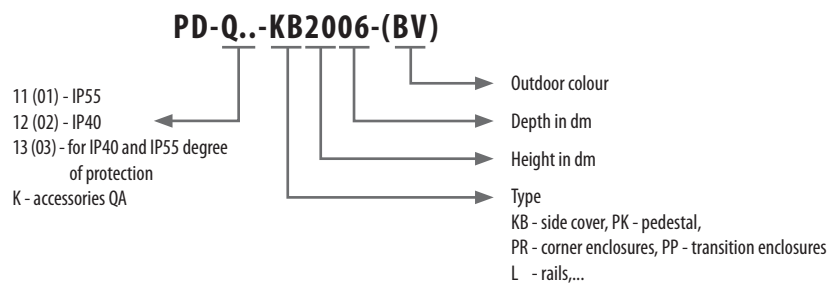

SIDE-BY-SIDE CABINETS QA

Heat dissipation

Frame dimensions			Power loss * [W]											
depth [mm]	width [mm]	height [mm]	□		□		□		□		□		□	
			QA55	QA40	QA55	QA40	QA55	QA40	QA55	QA40	QA55	QA40	QA55	QA40
300	600	1 800	251	280	219	293	239	252	196	218	213	236	178	196
		2 000	277	304	241	268	254	281	218	241	232	254	196	218
		2 200	310	340	268	304	281	308	245	272	259	286	218	245
	800	1 800	308	331	268	282	295	310	247	270	266	292	212	238
		2 000	334	371	290	322	313	344	268	295	290	317	245	268
		2 200	371	412	326	362	349	385	299	326	322	358	272	304
	1 000	1 800	317	349	259	286	303	344	268	331	295	322	241	272
		2 000	396	434	335	371	371	412	331	367	349	385	295	326
		2 200	470	515	412	443	430	484	394	403	403	448	353	380
	1 200	1 800	413	461	358	398	394	434	353	394	394	430	322	367
		2 000	335	371	290	322	313	344	268	295	290	317	245	268
		2 200	467	523	412	461	434	488	398	443	430	474	358	398
400	600	1 800	280	308	243	273	258	282	223	248	233	258	198	223
		2 000	307	338	268	298	283	313	243	268	258	283	218	243
		2 200	344	378	298	338	313	343	273	303	288	318	243	273
	800	1 800	338	373	293	323	318	348	273	303	293	323	248	273
		2 000	372	413	323	358	348	383	298	328	323	353	273	298
		2 200	412	458	363	403	388	428	333	363	358	398	303	338
	1 000	1 800	353	388	288	318	338	383	298	368	328	358	268	303
		2 000	439	483	373	413	413	458	368	408	388	428	328	363
		2 200	522	573	458	493	478	538	438	448	448	498	393	423
	1 200	1 800	458	513	398	443	438	483	393	438	438	478	358	408
		2 000	489	548	428	478	448	508	408	458	448	498	383	428
		2 200	510	582	458	512	483	542	443	493	478	527	398	443
500	600	1 800	312	346	277	313	278	313	252	283	253	283	218	253
		2 000	344	378	303	338	308	343	273	303	278	308	238	268
		2 200	379	423	338	378	343	383	303	338	308	343	293	323
	800	1 800	372	413	328	363	348	383	301	338	313	353	273	303
		2 000	407	453	358	398	378	418	328	363	348	383	298	328
		2 200	455	503	398	443	418	463	363	403	383	428	328	363
	1 000	1 800	394	343	328	363	373	418	328	383	353	388	293	328
		2 000	478	528	413	458	448	493	383	423	413	458	353	388
		2 200	552	608	498	528	513	573	468	463	473	528	413	448
	1 200	1 800	505	564	438	487	482	531	432	482	482	526	394	449
		2 000	523	588	463	518	488	548	448	498	483	533	403	448
		2 200	577	647	509	570	437	603	493	548	531	586	443	493
600	600	1 800	345	388	313	348	303	348	278	313	278	313	343	278
		2 000	378	418	338	373	343	378	298	333	303	339	263	293
		2 200	411	463	378	418	383	423	333	368	338	373	298	328
	800	1 800	406	453	363	403	378	418	333	373	343	393	293	343
		2 000	448	493	399	436	408	453	358	398	373	413	318	353
		2 200	500	548	438	488	453	503	393	438	408	453	353	393
	1 000	1 800	434	478	368	408	408	453	358	398	378	418	318	353
		2 000	527	581	454	504	493	542	421	465	454	504	388	427
		2 200	585	643	538	563	548	608	498	478	498	558	433	473
	1 200	1 800	554	621	482	536	530	584	475	530	530	578	433	494
		2 000	559	628	498	548	528	588	483	538	508	568	423	468
		2 200	638	711	560	627	590	663	542	603	584	645	488	542
800	600	1 800	380	428	350	387	331	384	306	346	304	340	369	301
		2 000	415	460	372	410	377	416	328	366	333	372	289	322
		2 200	458	509	416	460	421	465	366	405	372	410	328	361
	800	1 800	445	487	399	443	410	451	370	410	380	430	306	384
		2 000	494	542	438	482	449	498	394	438	410	454	349	388
		2 200	546	603	482	530	498	553	432	482	449	498	388	432
	1 000	1 800	476	526	405	449	449	498	394	438	416	460	350	388
		2 000	579	639	500	554	542	597	464	512	510	554	427	469
		2 200	671	736	603	639	621	693	566	560	572	639	500	542
	1 200	1 800	611	683	530	590	583	643	523	583	583	637	477	543
		2 000	615	691	548	603	581	647	531	592	559	625	465	515
		2 200	697	783	616	690	650	730	596	663	643	710	537	596
1 000	600	1 800	416	468	387	426	359	420	334	379	330	367	395	324
		2 000	452	502	406	447	411	454	358	399	363	406	315	351
		2 200	500	555	454	502	459	507	399	442	406	447	358	394
	800	1 800	485	521	435	483	442	484	407	447	417	467	319	425
		2 000	539	591	478	526	490	543	430	478	447	495	382	423
		2 200	598	658	526	572	543	603	471	526	490	543	423	471
	1 000	1 800	519	574	442	490	490	543	430	478	454	502	382	423
		2 000	631	697	546	604	591	652	507	559	566	604	466	511
		2 200	757	829	668	715	694	778	634	642	646	720	567	611

*) Power loss dissipated by the surface of the cabinet depending on degree of protection and location of the cabinet. Measurement of warming inside the cabinet $\Delta t = 15$ K at 3/4 cabinet height.

SIDE-BY-SIDE CABINETS QA

Dimensions

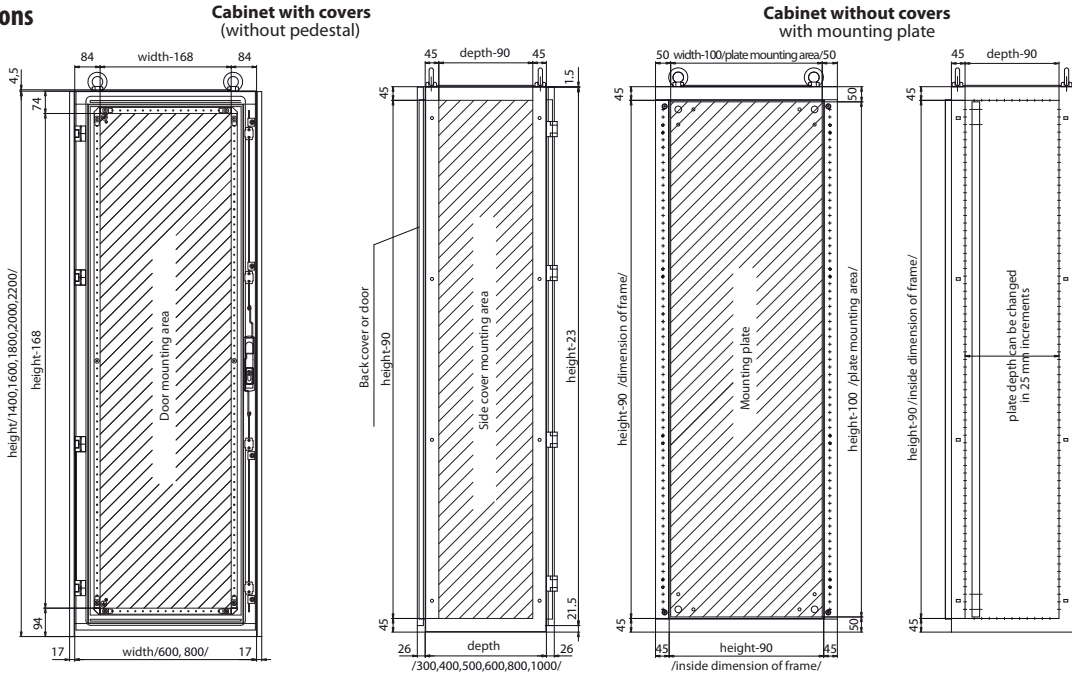

Top view of cabinet (without side covers, with top cover)

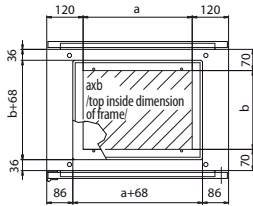

Cabinet bottom (with bottom sliding flanges)

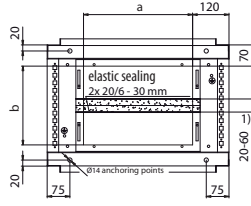

1) for cabinet depths 500, 600, 800, 1000 mm, there are 4 sliding flanges

Pedestal

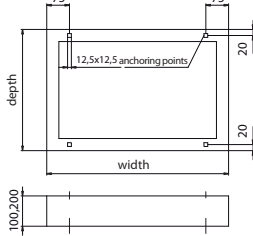

Cabinet without covers (without pedestal)

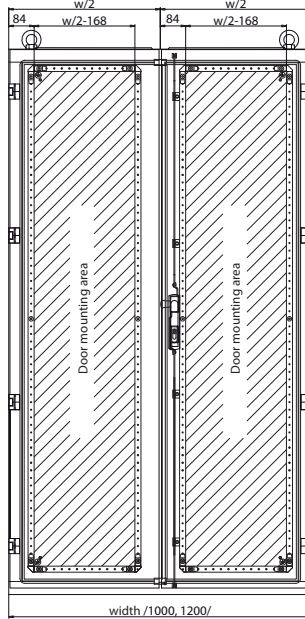

Top view of cabinet (without side covers, with top cover)

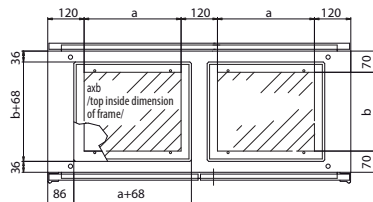

Cabinet bottom (with bottom sliding flanges)

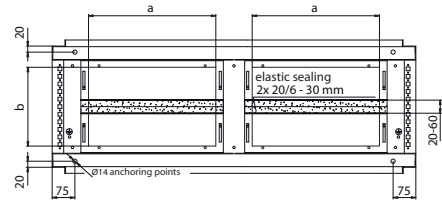

	For cabinet		Opening in bottom, upper cover	
	widths [mm]	depths [mm]	a [mm]	b [mm]
600	300	360	360	160
	400	360	360	260
	500	360	360	360
	600	360	360	460
	800	360	360	660
800	1000	360	860	
	300	560	160	
	400	560	260	
	500	560	360	
	600	560	460	
1000	800	560	660	
	1000	560	860	
	300	320	160	
	400	320	260	
	500	320	360	
1200	600	320	460	
	800	320	660	
	1000	320	860	
	300	420	160	
	400	420	260	

QA ACCESSORIES



PD-Q01-PR200606

Corner enclosures

- For joining QA.. cabinets of height 2 000 mm.
 - Corner enclosures can be in a structural group without transition enclosures.
 - For IP55 and IP40 degree of protection.
 - Fixed upper cover, side covers.
 - Thermoreactive epoxy-polyester powder coating RAL 7035.
- The package contains:
 - frame
 - 2 side rails.

Corner enclosure dimensions [mm]			Type	Order code	Weight [kg]	Package [pcs]
height	width (A)	depth (B)				
400	400	400	PD-Q01-PR200404	OEZ:33760	74	1
		600	PD-Q01-PR200406	OEZ:20911	74	1
		800	PD-Q01-PR200408	OEZ:20916	89	1
500	400	500	PD-Q01-PR200505	OEZ:33768	83	1
		600	PD-Q01-PR200506	OEZ:20913	76	1
		800	PD-Q01-PR200508	OEZ:20918	92	1
2 000	400	400	PD-Q01-PR200604	OEZ:20909	74	1
		500	PD-Q01-PR200605	OEZ:20912	76	1
		600	PD-Q01-PR200606	OEZ:20914	78	1
	600	800	PD-Q01-PR200608	OEZ:20696	101	1
		400	PD-Q01-PR200804	OEZ:20915	89	1
		500	PD-Q01-PR200805	OEZ:20917	92	1
	800	600	PD-Q01-PR200806	OEZ:20697	101	1
		800	PD-Q01-PR200808	OEZ:20698	110	1
		1 000	PD-Q01-PR200810	OEZ:44226	115	1
	1 000	800	PD-Q01-PR201008	OEZ:44225	118	1

Examples of joining into assembled group

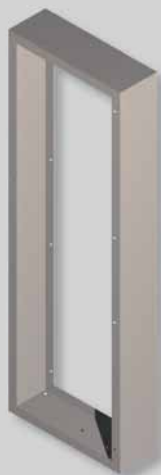
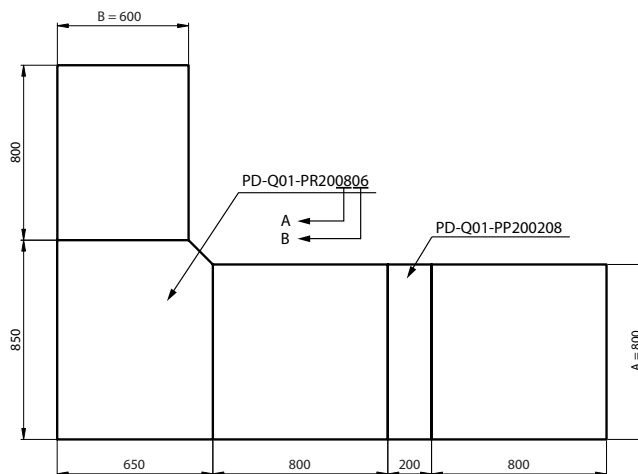

PD-Q01-PP200205

Transition enclosures

- For joining QA.. cabinets of height 2 000 mm.
 - For IP55 and IP40 degree of protection.
 - Thermoreactive epoxy-polyester powder coating RAL 7035.
- The package contains:
 - frame.

Transition enclosure dimensions [mm]			Type	Order code	Weight [kg]	Package [pcs]
height	width (A)	depth (B)				
2 000	200	300	PD-Q01-PP200203	OEZ:20919	55	1
		400	PD-Q01-PP200204	OEZ:20921	58	1
		500	PD-Q01-PP200205	OEZ:20922	60	1
		600	PD-Q01-PP200206	OEZ:20699	34	1
		800	PD-Q01-PP200208	OEZ:20700	38	1
		1 000	PD-Q01-PP200210	OEZ:41142	42	1

QA ACCESSORIES

Dimensions

Corner enclosure PD-Q01-PR.....

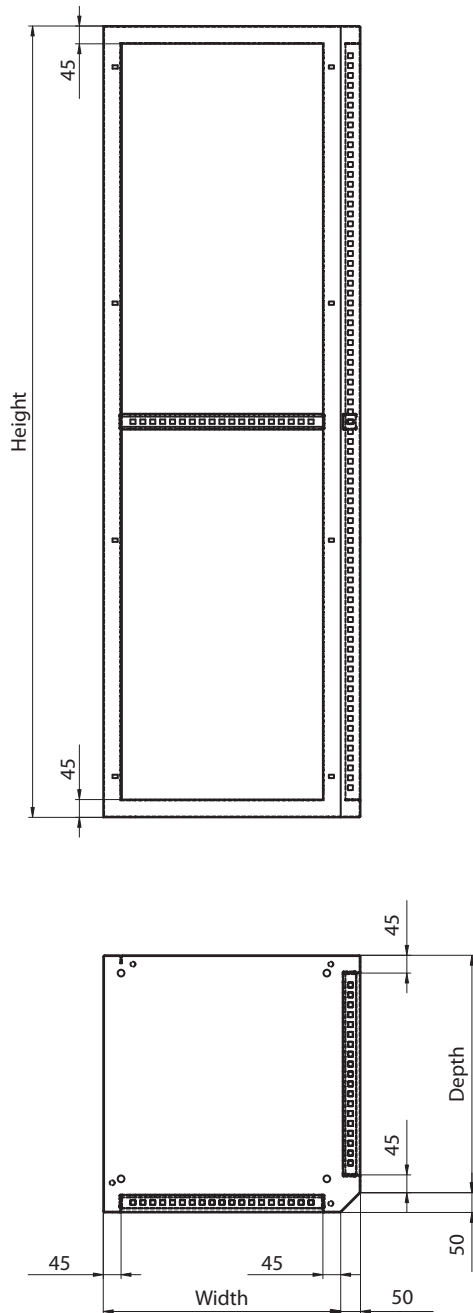

Pedestal PD-Q03PR-PK....

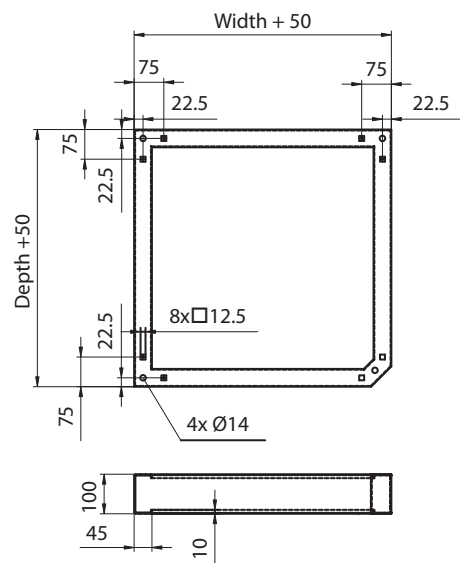

QA ACCESSORIES



PD-Q12-KB2004



PD-Q03-KBD2004

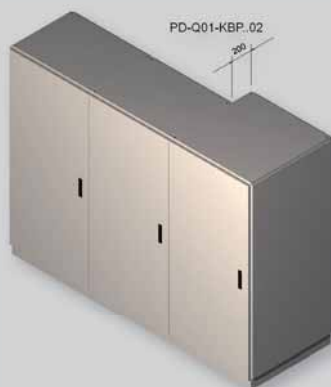

PD-Q12-KBP2002

Side covers

- 1.5 mm formed steel sheet.
- Fitted with sealing from expanded polyurethane for IP55 degree of protection.
- Thermoreactive epoxy-polyester powder coating RAL 7035.
- Fasten to frame using 8 M6x20 screws and M6 cage nuts.
- 1 earthing point for fastening of protective conductor.
- The package contains:
 - 2 side covers
 - fastening materials for fixing to frame.

For cabinet		For QA40 - Degree of protection IP40		For QA55 - Degree of protection IP55		Weight [kg]	Package [set]
height [mm]	depth [mm]	Type	Order code	Type	Order code		
1 800	300	PD-Q12-KB1803	OEZ:35589	PD-Q11-KB1803	OEZ:35571	13	1
	400	PD-Q12-KB1804	OEZ:35590	PD-Q11-KB1804	OEZ:35572	17	1
	500	PD-Q12-KB1805	OEZ:35591	PD-Q11-KB1805	OEZ:35573	21	1
	600	PD-Q12-KB1806	OEZ:35592	PD-Q11-KB1806	OEZ:35574	25	1
	800	PD-Q12-KB1808	OEZ:35593	PD-Q11-KB1808	OEZ:35575	34	1
	1 000	PD-Q12-KB1810	OEZ:35594	PD-Q11-KB1810	OEZ:35576	43	1
2 000	300	PD-Q12-KB2003	OEZ:35595	PD-Q11-KB2003	OEZ:35577	15	1
	400	PD-Q12-KB2004	OEZ:35596	PD-Q11-KB2004	OEZ:35578	19	1
	500	PD-Q12-KB2005	OEZ:35597	PD-Q11-KB2005	OEZ:35579	23	1
	600	PD-Q12-KB2006	OEZ:35598	PD-Q11-KB2006	OEZ:35580	27	1
	800	PD-Q12-KB2008	OEZ:35599	PD-Q11-KB2008	OEZ:35581	38	1
	1 000	PD-Q12-KB2010	OEZ:35600	PD-Q11-KB2010	OEZ:35582	49	1
2 200	300	PD-Q12-KB2203	OEZ:35601	PD-Q11-KB2203	OEZ:35583	17	1
	400	PD-Q12-KB2204	OEZ:35602	PD-Q11-KB2204	OEZ:35584	21	1
	500	PD-Q12-KB2205	OEZ:35603	PD-Q11-KB2205	OEZ:35585	25	1
	600	PD-Q12-KB2206	OEZ:35604	PD-Q11-KB2206	OEZ:35586	30	1
	800	PD-Q12-KB2208	OEZ:35605	PD-Q11-KB2208	OEZ:35587	42	1
	1 000	PD-Q12-KB2210	OEZ:35606	PD-Q11-KB2210	OEZ:35588	54	1

Dividing covers between cabinets

- For dividing enclosure areas in a group.
- Mounting between frames of adjacent enclosures.
- 1.5 mm steel sheet.
- Galvanised finish.
- Fitted with expanded polyurethane sealing for IP55 and IP40 degree of protection.
- The package contains:
 - dividing steel sheet
 - sealing.

For cabinet [mm]		Type	Order code	Weight [kg]	Package [set]
height	depth				
2 000	400	PD-Q03-KBD2004	OEZ:20702	9	1
	500	PD-Q03-KBD2005	OEZ:20703	12	1
	600	PD-Q03-KBD2006	OEZ:20704	15	1
	800	PD-Q03-KBD2008	OEZ:20705	19	1

Covers for variable depths of cabinets

- For covering side areas in cabinet group with variable depths.
- Fitted with sealing from expanded polyurethane for IP55 degree of protection.
- 1.5 mm formed steel sheet.
- Thermoreactive epoxy-polyester powder coating RAL 7035.
- The package contains:
 - cover
 - web
 - fastening material.

For cabinets [mm]		Degree of protection IP40		Degree of protection IP55		Weight [kg]	Package [pcs]
height	variable depth	Type	Order code	Type	Order code		
2 000	200	PD-Q12-KBP2002	OEZ:35750	PD-Q11-KBP2002	OEZ:35748	6.5	1
2 200	200	PD-Q12-KBP2202	OEZ:35751	PD-Q11-KBP2202	OEZ:35749	7.0	1

QA ACCESSORIES

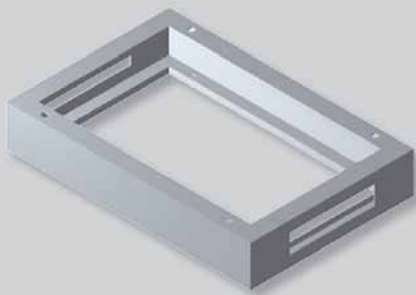

PD-Q13-PK010805

Pedestals

- 2 mm formed steel sheet.
- Thermoreactive epoxy-polyester powder coating RAL 7035.
- Fasten to frame using 4 M10x30 screws.
- 4 holes (12.5 x 12.5 mm) for fastening to floor.
- Side hole for additional extension of cables between enclosures.
- Side holes can be covered with PD-RI-ZAS-S blind plates. 2 blind plate per one opening.
- The package contains:
 - pedestal
 - fastening materials for fixing to frame.

	For cabinet		Type	Order code	Pedestal height [mm]	Weight [kg]	Package [sets]
	width [mm]	depth [mm]					
600	300		PD-Q13-PK010603	OEZ:35607	100	5.8	1
	400		PD-Q13-PK010604	OEZ:35608	100	6.4	1
	500		PD-Q13-PK010605	OEZ:35609	100	7.1	1
	600		PD-Q13-PK010606	OEZ:35610	100	7.7	1
	800		PD-Q13-PK010608	OEZ:35611	100	8.9	1
	1000		PD-Q13-PK010610	OEZ:35612	100	10.1	1
800	300		PD-Q13-PK010803	OEZ:35613	100	7.1	1
	400		PD-Q13-PK010804	OEZ:35614	100	7.7	1
	500		PD-Q13-PK010805	OEZ:35615	100	8.4	1
	600		PD-Q13-PK010806	OEZ:35616	100	9.0	1
	800		PD-Q13-PK010808	OEZ:35617	100	10.3	1
	1000		PD-Q13-PK010810	OEZ:35618	100	11.6	1
1000	300		PD-Q13-PK011003	OEZ:35619	100	8.5	1
	400		PD-Q13-PK011004	OEZ:35620	100	9.1	1
	500		PD-Q13-PK011005	OEZ:35621	100	9.7	1
	600		PD-Q13-PK011006	OEZ:35622	100	10.4	1
	800		PD-Q13-PK011008	OEZ:35623	100	11.6	1
	1000		PD-Q13-PK011010	OEZ:35624	100	12.9	1
1200	300		PD-Q13-PK011203	OEZ:35625	100	9.9	1
	400		PD-Q13-PK011204	OEZ:35626	100	10.5	1
	500		PD-Q13-PK011205	OEZ:35627	100	11.1	1
	600		PD-Q13-PK011206	OEZ:35628	100	11.7	1
	800		PD-Q13-PK011208	OEZ:35629	100	12.9	1
600	300		PD-Q13-PK020603	OEZ:35630	200	8.7	1
	400		PD-Q13-PK020604	OEZ:35631	200	9.6	1
	500		PD-Q13-PK020605	OEZ:35632	200	10.6	1
	600		PD-Q13-PK020606	OEZ:35633	200	11.6	1
	800		PD-Q13-PK020608	OEZ:35634	200	13.4	1
	1000		PD-Q13-PK020610	OEZ:35635	200	15.2	1
800	300		PD-Q13-PK020803	OEZ:35636	200	10.7	1
	400		PD-Q13-PK020804	OEZ:35637	200	11.6	1
	500		PD-Q13-PK020805	OEZ:35638	200	12.5	1
	600		PD-Q13-PK020806	OEZ:35639	200	13.5	1
	800		PD-Q13-PK020808	OEZ:35640	200	15.4	1
	1000		PD-Q13-PK020810	OEZ:35641	200	17.3	1
1000	300		PD-Q13-PK021003	OEZ:35642	200	12.8	1
	400		PD-Q13-PK021004	OEZ:35643	200	13.7	1
	500		PD-Q13-PK021005	OEZ:35644	200	14.6	1
	600		PD-Q13-PK021006	OEZ:35645	200	15.5	1
	800		PD-Q13-PK021008	OEZ:35646	200	17.3	1
	1000		PD-Q13-PK021010	OEZ:35647	200	19.4	1
1200	300		PD-Q13-PK021203	OEZ:35648	200	14.9	1
	400		PD-Q13-PK021204	OEZ:35649	200	15.8	1
	500		PD-Q13-PK021205	OEZ:35650	200	16.7	1
	600		PD-Q13-PK021206	OEZ:35651	200	17.6	1
	800		PD-Q13-PK021208	OEZ:35652	200	19.4	1

QA ACCESSORIES

Pedestals with ventilation

- 2 mm formed steel sheet.
- Thermoreactive epoxy-polyester powder coating RAL 7035.
- Fasten to frame using 4 M10x30 screws.
- 4 holes (12.5 x 12.5 mm) for fastening to floor.
- Side hole for additional extension of cables between enclosures.
- Degree of protection IP2x with covered side holes.
- Ventilation ensured by holes with blinds in front and back side of pedestal.
- Side holes can be covered with PD-RI-ZAS-S blind plates. 2 blind plates per one opening.
- The package contains:
 - pedestal
 - fastening materials for fixing to frame.

Pedestal height [mm]	Frame dimensions [mm]		Type	Order code	Ventilation hole [cm ²]	Weight [kg]	Package [pcs]
	width	depth					
600		300	PD-Q13-PKV010603	OEZ:38559	37	5.80	1
		400	PD-Q13-PKV010604	OEZ:38560	37	6.40	1
		500	PD-Q13-PKV010605	OEZ:38561	37	7.05	1
		600	PD-Q13-PKV010606	OEZ:38562	37	7.70	1
		800	PD-Q13-PKV010608	OEZ:38563	37	8.90	1
		1 000	PD-Q13-PKV010610	OEZ:38564	37	10.10	1
800		300	PD-Q13-PKV010803	OEZ:38565	47	7.10	1
		400	PD-Q13-PKV010804	OEZ:38566	47	7.70	1
		500	PD-Q13-PKV010805	OEZ:38567	47	8.35	1
		600	PD-Q13-PKV010806	OEZ:38568	47	9.00	1
		800	PD-Q13-PKV010808	OEZ:38569	47	10.25	1
		1 000	PD-Q13-PKV010810	OEZ:38570	47	11.55	1
1 000		300	PD-Q13-PKV011003	OEZ:38571	56	8.50	1
		400	PD-Q13-PKV011004	OEZ:38572	56	9.10	1
		500	PD-Q13-PKV011005	OEZ:38573	56	9.72	1
		600	PD-Q13-PKV011006	OEZ:38574	56	10.35	1
		800	PD-Q13-PKV011008	OEZ:38575	56	11.55	1
		1 000	PD-Q13-PKV011010	OEZ:38576	56	12.90	1
1 200		300	PD-Q13-PKV011203	OEZ:38577	66	9.90	1
		400	PD-Q13-PKV011204	OEZ:38578	66	10.50	1
		500	PD-Q13-PKV011205	OEZ:38579	66	11.10	1
		600	PD-Q13-PKV011206	OEZ:38580	66	11.70	1
		800	PD-Q13-PKV011208	OEZ:38581	66	12.90	1

QA ACCESSORIES



PD-Q03PR-PK010406

Pedestals for corner enclosures

- For PD-Q01-PR.. corner enclosure.
 - 2 mm formed steel sheet.
 - Thermoreactive epoxy-polyester powder coating RAL 7035.
 - Fasten to frame using 4 M10x30 screws.
 - 4 holes (12.5 x 12.5 mm) for fastening to floor.
- The package contains:
 - pedestal
 - fastening materials for fixing to frame.

Pedestal height [mm]	Frame dimensions [mm]		Type	Order code	Weight [kg]	Package [sets]
	width	depth				
100	400	400	PD-Q03PR-PK010404	OEZ:34648	4.00	1
		600	PD-Q03PR-PK010406	OEZ:21117	6.40	1
		800	PD-Q03PR-PK010408	OEZ:21121	7.70	1
	500	500	PD-Q03PR-PK010505	OEZ:33767	5.00	1
		600	PD-Q03PR-PK010506	OEZ:21119	7.10	1
		800	PD-Q03PR-PK010508	OEZ:21123	8.40	1
	600	400	PD-Q03PR-PK010604	OEZ:21116	6.40	1
		500	PD-Q03PR-PK010605	OEZ:21118	7.10	1
		600	PD-Q03PR-PK010606	OEZ:15979	7.50	1
	800	800	PD-Q03PR-PK010608	OEZ:20714	8.50	1
		400	PD-Q03PR-PK010804	OEZ:21120	7.70	1
		500	PD-Q03PR-PK010805	OEZ:21122	8.40	1
600		PD-Q03PR-PK010806	OEZ:20715	8.50	1	
800		PD-Q03PR-PK010808	OEZ:20716	10.50	1	
1 000		PD-Q03PR-PK010810	OEZ:44228	11.55	1	
1 000	800	PD-Q03PR-PK011008	OEZ:44227	11.55	1	



PD-Q03PP-PK010206

Pedestals for transition enclosures

- For PD-Q01-PP.. transition enclosures..
 - 2 mm formed steel sheet.
 - Thermoreactive epoxy-polyester powder coating RAL 7035.
 - Fasten to frame using 4 M10x30 screws.
 - 4 holes (12.5 x 12.5 mm) for fastening to floor.
- The package contains:
 - pedestal
 - fastening materials for fixing to frame.

Pedestal height [mm]	Frame dimensions [mm]		Type	Order code	Weight [kg]	Package [sets]
	width	depth				
100	200	300	PD-Q03PP-PK010203	OEZ:33408	3.0	1
		400	PD-Q03PP-PK010204	OEZ:33409	3.5	1
		500	PD-Q03PP-PK010205	OEZ:33410	4.0	1
		600	PD-Q03PP-PK010206	OEZ:15980	4.5	1
		800	PD-Q03PP-PK010208	OEZ:33411	5.5	1
		1 000	PD-Q03PP-PK010210	OEZ:41143	6.5	1

QA ACCESSORIES



PD-Q13-3KD0808

Bottom sliding flanges

- 1.5 mm formed steel sheet.
- Sealing for cable pass-through.
- Does not serve to achieve degree of protection of cabinet bottom.
- Galvanised finish.
- Can be used in QA cabinet upper cover instead of removable upper cover.
- The package contains:
 - set of sliding flanges
 - connection material.

For cabinet		Type	Order code	Number of covers in the set [pcs]	Number of cable bushes in cover	Weight [kg]	Package [sets]
width [mm]	depth [mm]						
600	300	PD-Q13-3KD0603	OEZ:35752	2	1	1.0	1
	400	PD-Q13-3KD0604	OEZ:35753	2	1	1.4	1
	500	PD-Q13-3KD0605	OEZ:35754	4	2	2.2	1
	600	PD-Q13-3KD0606	OEZ:35755	4	2	2.7	1
	800	PD-Q13-3KD0608	OEZ:35756	4	2	3.9	1
	1 000	PD-Q13-3KD0610	OEZ:35757	4	2	4.6	1
800	300	PD-Q13-3KD0803	OEZ:35758	2	1	1.4	1
	400	PD-Q13-3KD0804	OEZ:35759	2	1	2.2	1
	500	PD-Q13-3KD0805	OEZ:35760	4	2	3.2	1
	600	PD-Q13-3KD0806	OEZ:35761	4	2	3.9	1
	800	PD-Q13-3KD0808	OEZ:35762	4	2	5.9	1
	1 000	PD-Q13-3KD0810	OEZ:35763	4	2	6.9	1
1 000	300	PD-Q13-3KD1003	OEZ:35764	4	2x 1	1.7	1
	400	PD-Q13-3KD1004	OEZ:35765	4	2x 1	2.6	1
	500	PD-Q13-3KD1005	OEZ:35766	8	2x 2	3.9	1
	600	PD-Q13-3KD1006	OEZ:35767	8	2x 2	4.7	1
	800	PD-Q13-3KD1008	OEZ:35768	8	2x 2	7.1	1
	1 000	PD-Q13-3KD1010	OEZ:35769	8	2x 2	8.4	1
1 200	300	PD-Q13-3KD1203	OEZ:35770	4	2x 1	2.2	1
	400	PD-Q13-3KD1204	OEZ:35771	4	2x 1	3.3	1
	500	PD-Q13-3KD1205	OEZ:35772	8	2x 2	4.9	1
	600	PD-Q13-3KD1206	OEZ:35773	8	2x 2	6.4	1
	800	PD-Q13-3KD1208	OEZ:35774	8	2x 2	9.1	1



PD-Q13-1KD0804

One-piece bottom covers

- 1.5 mm formed steel sheet.
- Ensures IP55 degree of protection of cabinet bottom.
- Galvanised finish.
- The package contains:
 - cover
 - sealing
 - connection material.

For cabinet		Type	Order code	Weight [kg]	Package [sets]
width [mm]	depth [mm]				
600	300	PD-Q13-1KD0603	OEZ:35775	0.9	1
	400	PD-Q13-1KD0604	OEZ:35776	1.3	1
	500	PD-Q13-1KD0605	OEZ:35777	1.7	1
	600	PD-Q13-1KD0606	OEZ:35778	2.2	1
	800	PD-Q13-1KD0608	OEZ:35779	3.1	1
	1 000	PD-Q13-1KD0610	OEZ:35780	4.0	1
800	300	PD-Q13-1KD0803	OEZ:35781	1.3	1
	400	PD-Q13-1KD0804	OEZ:35782	1.9	1
	500	PD-Q13-1KD0805	OEZ:35783	2.6	1
	600	PD-Q13-1KD0806	OEZ:35784	3.3	1
	800	PD-Q13-1KD0808	OEZ:35785	4.7	1
	1 000	PD-Q13-1KD0810	OEZ:35786	6.1	1
1 000	300	PD-Q13-1KD1003	OEZ:35787	1.3	1
	400	PD-Q13-1KD1004	OEZ:35788	2.5	1
	500	PD-Q13-1KD1005	OEZ:35789	3.4	1
	600	PD-Q13-1KD1006	OEZ:35790	4.2	1
	800	PD-Q13-1KD1008	OEZ:35791	5.9	1
	1 000	PD-Q13-1KD1010	OEZ:35792	7.7	1
1 200	300	PD-Q13-1KD1203	OEZ:35793	2.1	1
	400	PD-Q13-1KD1204	OEZ:35794	3.1	1
	500	PD-Q13-1KD1205	OEZ:35795	4.2	1
	600	PD-Q13-1KD1206	OEZ:35796	5.0	1
	800	PD-Q13-1KD1208	OEZ:35797	7.5	1

QA ACCESSORIES

Upper covers with ventilation

- 1.5 mm formed steel sheet.
 - Thermoreactive epoxy-polyester powder coating RAL 7035.
 - Mounting between frames and upper cover.
 - Height 100 mm.
 - Degree of protection IP2x.
 - Ventilation ensured by holes with blinds around the cover periphery.
- The package contains:
 - 1 cover for cabinets of width 600 and 800 mm
 - 2 covers for cabinets of width 1 000 and 1 200 mm
 - fastening materials for fixing to frame.

Cabinet dimensions [mm]		Type	Order code	Venting hole [cm ²]	Weight [kg]	Package [sets]
width	depth					
600	300	PD-Q13-KHV0603	OEZ:38582	37	3.50	1
	400	PD-Q13-KHV0604	OEZ:38583	47	4.00	1
	500	PD-Q13-KHV0605	OEZ:38584	56	4.50	1
	600	PD-Q13-KHV0606	OEZ:38585	66	5.00	1
	800	PD-Q13-KHV0608	OEZ:38586	84	5.95	1
	1 000	PD-Q13-KHV0610	OEZ:38587	103	6.95	1
800	300	PD-Q13-KHV0803	OEZ:38588	56	4.30	1
	400	PD-Q13-KHV0804	OEZ:38589	66	4.80	1
	500	PD-Q13-KHV0805	OEZ:38590	75	5.30	1
	600	PD-Q13-KHV0806	OEZ:38591	84	5.80	1
	800	PD-Q13-KHV0808	OEZ:38592	103	6.70	1
	1 000	PD-Q13-KHV0810	OEZ:38593	122	7.70	1
1 000	300	PD-Q13-KHV1003	OEZ:38594	75	8.30	1
	400	PD-Q13-KHV1004	OEZ:38595	94	9.00	1
	500	PD-Q13-KHV1005	OEZ:38596	112	9.70	1
	600	PD-Q13-KHV1006	OEZ:38597	131	10.50	1
	800	PD-Q13-KHV1008	OEZ:38598	168	11.75	1
	1 000	PD-Q13-KHV1010	OEZ:38599	356	13.00	1
1 200	300	PD-Q13-KHV1203	OEZ:38600	94	9.00	1
	400	PD-Q13-KHV1204	OEZ:38601	112	9.70	1
	500	PD-Q13-KHV1205	OEZ:38602	131	10.50	1
	600	PD-Q13-KHV1206	OEZ:38603	150	11.30	1
	800	PD-Q13-KHV1208	OEZ:38604	187	13.00	1

QA ACCESSORIES



PD-Q03-MP1908



PD-Q13-LMP06



PD-Q03-MPV19

Mounting plates

- 2.5 mm formed steel sheet.
- Galvanised finish.
- Fasten to frame using 4 pcs of brackets.
- The package contains:
 - mounting plate
 - 4 brackets
 - fastening material.

For cabinet		Type	Order code	Plate height [mm]	Plate width [mm]	Plate surface area [m ²]	Weight [kg]	Package [pcs]
height [mm]	width [mm]							
1 800	600	PD-Q03-MP1706	OEZ:17499	1 700	500	0.85	21.0	1
	800	PD-Q03-MP1708	OEZ:17500	1 700	700	1.19	28.0	1
	1 000	PD-Q03-MP1710	OEZ:17601	1 700	900	1.53	35.0	1
	1 200	PD-Q03-MP1712	OEZ:17602	1 700	1100	1.87	42.0	1
2 000	600	PD-Q03-MP1906	OEZ:17603	1 900	500	0.95	23.5	1
	800	PD-Q03-MP1908	OEZ:17604	1 900	700	1.39	31.5	1
	1 000	PD-Q03-MP1910	OEZ:17605	1 900	900	1.71	39.0	1
	1 200	PD-Q03-MP1912	OEZ:17606	1 900	1100	2.09	47.0	1
2 200	600	PD-Q03-MP2106	OEZ:17607	2 100	500	1.05	26.5	1
	800	PD-Q03-MP2108	OEZ:17608	2 100	700	1.47	35.0	1
	1 000	PD-Q03-MP2110	OEZ:17609	2 100	900	1.89	44.0	1
	1 200	PD-Q03-MP2112	OEZ:21132	2 100	1100	2.31	53.0	1

Rails for easy mounting of mounting plate

- Facilitate insertion of fitted mounting panel.
- Placed into cabinet bottom.
- Serve as a support for heavy load of mounting plate.
- The package contains:
 - 2 rails
 - fastening material.

For cabinet depth [mm]	Type	Order code	Weight [kg]	Package [sets]
400	PD-Q13-LMP04	OEZ:35798	1.4	1
500	PD-Q13-LMP05	OEZ:35799	1.9	1
600	PD-Q13-LMP06	OEZ:35800	2.2	1
800	PD-Q13-LMP08	OEZ:35801	3.5	1
1 000	PD-Q13-LMP10	OEZ:35802	4.7	1

Filler plates between mounting plates

- Used for filling space between mounting plates in concurring multiple connection cabinets with mounting plates.
- 2.5 mm formed steel sheet.
- Mounting on cabinet back webs.
- Galvanised finish.
- The package contains:
 - filler plate
 - fastening material.

For cabinet height [mm]	Type	Order code	Weight [kg]	Package [pcs]
1 800	PD-Q03-MPV17	OEZ:17610	5.0	1
2 000	PD-Q03-MPV19	OEZ:17611	6.0	1
2 200	PD-Q03-MPV21	OEZ:17612	7.0	1

QA ACCESSORIES

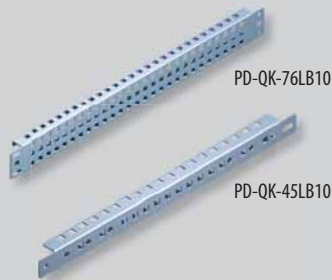
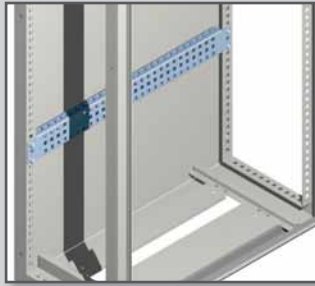

Rails for back mounting

- Fasten at the level of cabinet back perforation, width.
- 2 mm formed steel sheet, "C" profile.
- Galvanised finish.
- Perforated for size M8 cage nuts.
- The package contains:
 - 1 rail
 - fastening material.

For cabinet width [mm]	Typ	Order code	Rails height [mm]	Weight [kg]	Package [pcs]
600	PD-QK-45LB06	OEZ:17617	40	0.8	1
800	PD-QK-45LB08	OEZ:17618	40	1.0	1
1 000	PD-QK-45LB10	OEZ:17619	40	1.2	1
1 200	PD-Q03-45LB12	OEZ:17620	40	1.3	1
600	PD-QK-76LB06	OEZ:17613	76	1.1	1
800	PD-QK-76LB08	OEZ:17614	76	1.4	1
1 000	PD-QK-76LB10	OEZ:17615	76	1.6	1
1 200	PD-Q03-76LB12	OEZ:17616	76	1.8	1

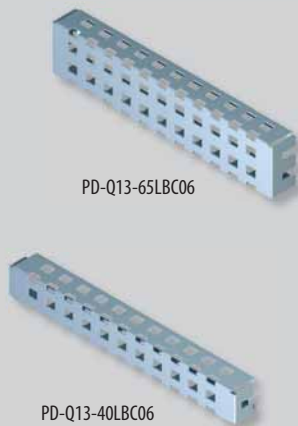
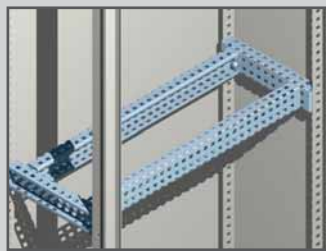

Rails for side/front mounting of components

- For mechanical fastening of heavy devices into cabinets.
- 1.5 mm formed steel sheet.
- Galvanised finish.
- Perforated for size M8 cage nuts.
- The package contains:
 - 1 rail
 - fastening material.

For cabinet		Type	Order code	Rails height [mm]	Weight [kg]	Package [pcs]
width [mm]	depth [mm]					
-	300	PD-Q13-40LBC03	OEZ:35809	40	0.5	1
-	400	PD-Q13-40LBC04	OEZ:35810	40	0.6	1
-	500	PD-Q13-40LBC05	OEZ:35811	40	0.7	1
600	600	PD-Q13-40LBC06	OEZ:35812	40	0.8	1
800	800	PD-Q13-40LBC08	OEZ:35813	40	1.0	1
1 000	1 000	PD-Q13-40LBC10	OEZ:35814	40	1.2	1
-	400	PD-Q13-65LBC04	OEZ:35803	65	0.8	1
-	500	PD-Q13-65LBC05	OEZ:35804	65	0.9	1
600	600	PD-Q13-65LBC06	OEZ:35805	65	1.0	1
800	800	PD-Q13-65LBC08	OEZ:35806	65	1.3	1
1 000	1 000	PD-Q13-65LBC10	OEZ:35807	65	1.5	1
1 200	-	PD-Q13-65LBC12	OEZ:35808	65	1.8	1
-	500	PD-Q13-115LBC05	OEZ:45508	115	1.1	1
600	600	PD-Q13-115LBC06	OEZ:45509	115	1.2	1
800	800	PD-Q13-115LBC08	OEZ:43554	115	1.5	1
1 000	1 000	PD-Q13-115LBC10	OEZ:45510	115	1.8	1
1 200	-	PD-Q13-115LBC12	OEZ:43555	115	2.1	1

QA ACCESSORIES

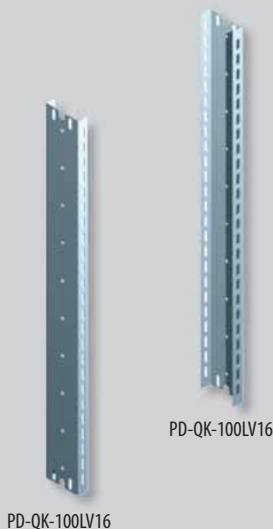

PD-QK-100LV16

PD-QK-100LV16

Vertical rails

- Used as a load-bearing element for attaching device rails.
 - Fasten to cabinet on side rails or between upper and lower frame perforation using PD-QK-1D, PD-QK-2D brackets.
 - 2 mm formed steel sheet.
 - Height of bend 30 mm.
 - 9 x 30 mm ovals on both sides for mounting device rails.
 - Holes on side for anchoring wiring duct.
 - Galvanised finish.
- The package contains:
 - 1 rail
 - fastening material.

For cabinet height [mm]	Type	Order code	Rail [mm]		Weight [kg]	Package [sets]
			width	length		
2 200	PD-QK-100LV06	OEZ:17632	100	600	1.5	1
	PD-QK-100LV10	OEZ:17633	100	1 000	2.4	1
	PD-QK-100LV12	OEZ:17634	100	1 200	2.9	1
	PD-QK-100LV14	OEZ:17635	100	1 400	3.4	1
	PD-QK-100LV16	OEZ:17636	100	1 600	4.4	1
	PD-QK-100LV17	OEZ:21136	100	1 700	4.8	1
	PD-QK-100LV18	OEZ:17637	100	1 800	5.2	1
	PD-QK-100LV19	OEZ:20736	100	1 900	6.0	1
	PD-QK-100LV21	OEZ:21137	100	2 100	7.0	1
	2 000	PD-QK-50LV10	OEZ:17638	50	1 000	1.7
PD-QK-50LV12		OEZ:17639	50	1 200	2.0	1
PD-QK-50LV16		OEZ:17640	50	1 600	2.7	1
PD-QK-50LV17		OEZ:21138	50	1 700	2.9	1
PD-QK-50LV18		OEZ:17641	50	1 800	3.0	1
PD-QK-50LV19		OEZ:20737	50	1 900	3.5	1
2 200	PD-QK-50LV21	OEZ:20738	50	2 100	4.0	1

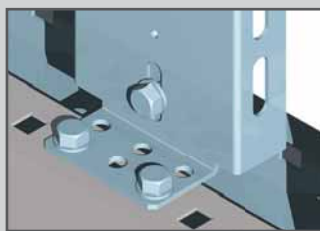

Vertical rail brackets

- For QA55, QA40 cabinets.
 - For fastening vertical rails at the bottom or top.
 - 2.5 mm formed steel sheet.
 - Galvanised finish.
- The package contains:
 - 2 brackets
 - fastening material.

Type	Order code	For rail	Weight [kg]	Package [sets]
PD-QK-1D	OEZ:17642	PD-QK-100LV..	0.2	1
PD-QK-2D	OEZ:35815	PD-QK-50LV..	0.2	1



PD-QK-1D

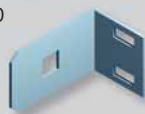

PD-QK-2D

QA ACCESSORIES

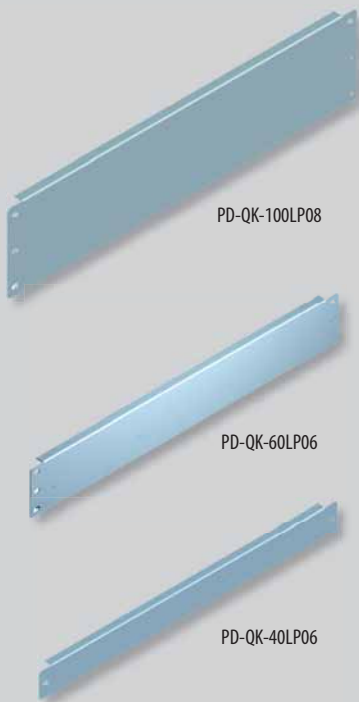

PD-QK-100LP08

PD-QK-60LP06

PD-QK-40LP06



PD-QK-DP1

Device rails

- For QA55, QA40 cabinets.
 - For fastening light and moderately heavy devices on vertical rails.
 - 2 mm steel sheet formed to "U" profile.
 - With 17 mm height of bend.
 - Galvanised finish.
- The package contains:
 - 1 rail
 - fastening material.

For cabinet width [mm]	Type	Order code	Rails of height [mm]	Weight [kg]	Package [pcs]
600	PD-QK-40LP06	OEZ:17643	40	0.6	1
	PD-QK-60LP06	OEZ:17644	60	0.8	1
	PD-QK-80LP06	OEZ:17645	80	1.0	1
	PD-QK-100LP06	OEZ:17646	100	1.2	1
	PD-QK-120LP06	OEZ:17647	120	1.4	1
	PD-QK-150LP06	OEZ:17648	150	1.6	1
	PD-QK-160LP06	OEZ:17649	160	1.8	1
	PD-QK-200LP06	OEZ:17650	200	2.0	1
800	PD-QK-40LP08	OEZ:17651	40	0.8	1
	PD-QK-60LP08	OEZ:17652	60	1.0	1
	PD-QK-80LP08	OEZ:17653	80	1.2	1
	PD-QK-100LP08	OEZ:17654	100	1.4	1
	PD-QK-120LP08	OEZ:17655	120	1.6	1
	PD-QK-150LP08	OEZ:17656	150	1.8	1
	PD-QK-160LP08	OEZ:17657	160	2.0	1
	PD-QK-200LP08	OEZ:17658	200	2.2	1
1 000	PD-QK-40LP10	OEZ:17659	40	1.0	1
	PD-QK-60LP10	OEZ:17660	60	1.2	1
	PD-QK-80LP10	OEZ:17661	80	1.4	1
	PD-QK-100LP10	OEZ:17662	100	1.6	1
	PD-QK-120LP10	OEZ:17663	120	1.8	1
	PD-QK-150LP10	OEZ:17664	150	2.0	1
	PD-QK-160LP10	OEZ:17665	160	2.2	1
	PD-QK-200LP10	OEZ:17666	200	2.9	1
1 200	PD-QK-80LP12	OEZ:20739	80	1.6	1
	PD-QK-100LP12	OEZ:20740	100	1.8	1
	PD-QK-160LP12	OEZ:20741	160	2.4	1
	PD-QK-200LP12	OEZ:20742	200	2.9	1

Sliding brackets of the device rail

- For creating depth adjustable device rack.
 - Enable fastening of PD-QK-...LP.. device rails to PD-QK-...LV... vertical rails or PD-Q13-M.. modular system at the required depth.
 - Recommended use for PD-QK-...LP..
 - to the height 120 mm 1 set
 - to the height 150 mm 2 sets.
 - Option of offsetting in 12.5 mm increments; offset range from 27 to 143 mm.
 - By rotating plate, fully adjustable from 12 to 124 mm.
- 2.5 mm formed steel sheet.
 - Galvanised finish.
 - The package contains:
 - 2 brackets
 - fastening material.

Type	Order code	Weight [kg]	Package [sets]
PD-QK-DP1	OEZ:20743	0.4	1

QA ACCESSORIES

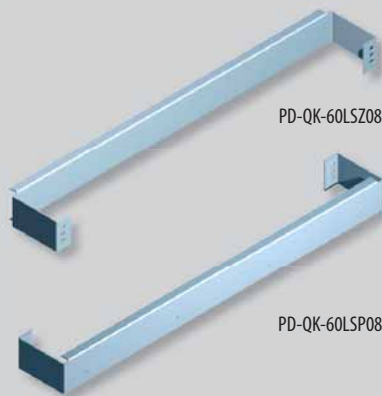

Front and back terminal rails

- For fastening terminal strips or light devices (e.g. LPN miniature circuit breakers) on vertical rails with 100 mm off set to front or back.
- 2 mm steel sheet formed to "U" profile, with 17 mm height of bend.
- On front side 3.2 mm holes \varnothing with 200 mm spacing for "U" rails mounting.
- Galvanised finish.
- The package contains:
 - 1 rail
 - connection material.

For cabinet width [mm]	Type	Order code	Rail of height [mm]	Rail design	Weight [kg]	Package [pcs]
600	PD-QK-60LSP06	OEZ:19738	60	Front	1.0	1
800	PD-QK-60LSP08	OEZ:19739	60	Front	1.3	1
1 000	PD-QK-60LSP10	OEZ:19740	60	Front	1.6	1
600	PD-QK-60LSZ06	OEZ:19741	60	Rear	1.0	1
800	PD-QK-60LSZ08	OEZ:19742	60	Rear	1.3	1
1 000	PD-QK-60LSZ10	OEZ:19743	60	Rear	1.6	1



Terminal blocks brackets

- For fastening terminal strips at a 30° angle.
- 2 mm steel sheet, width 20 mm.
- Galvanised finish.
- The package contains:
 - 1 bracket
 - connection material.

Type	Order code	Holder of height [mm]	Weight [kg]	Package [pcs]
PD-QT-DSM	OEZ:19744	90	0.20	1
PD-QT-DSV	OEZ:19745	160	0.35	1

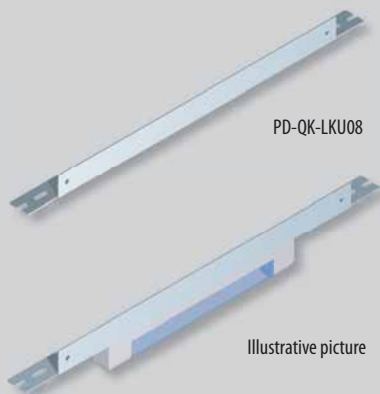

Rails for cable holders Sonap

- For fastening cables using holders Sonap.
- For mounting on vertical rails, cabinet bottom frame holes or top perforation as PD-QK-OSL light bracket.
- 2 mm steel sheet, "L" profile 40 x 40 mm.
- Galvanised finish.
- The package contains:
 - 1 rail
 - connection material.

For cabinet width [mm]	Type	Order code	Weight [kg]	Package [pcs]
600	PD-QK-LKU06	OEZ:20744	0.7	1
800	PD-QK-LKU08	OEZ:20745	1.0	1
1 000	PD-QK-LKU10	OEZ:20746	1.3	1
1 200	PD-QK-LKU12	OEZ:20747	1.6	1

QA ACCESSORIES

Modular system description

Modular system - modular rails

■ PD-Q13-M..

Modular system - vertical outer covers

■ PD-Q13-KMM..

Modular system - covers

■ PD-Q13-KM(V)..

Modular system - horizontal outer covers

■ PD-Q13-KMK..

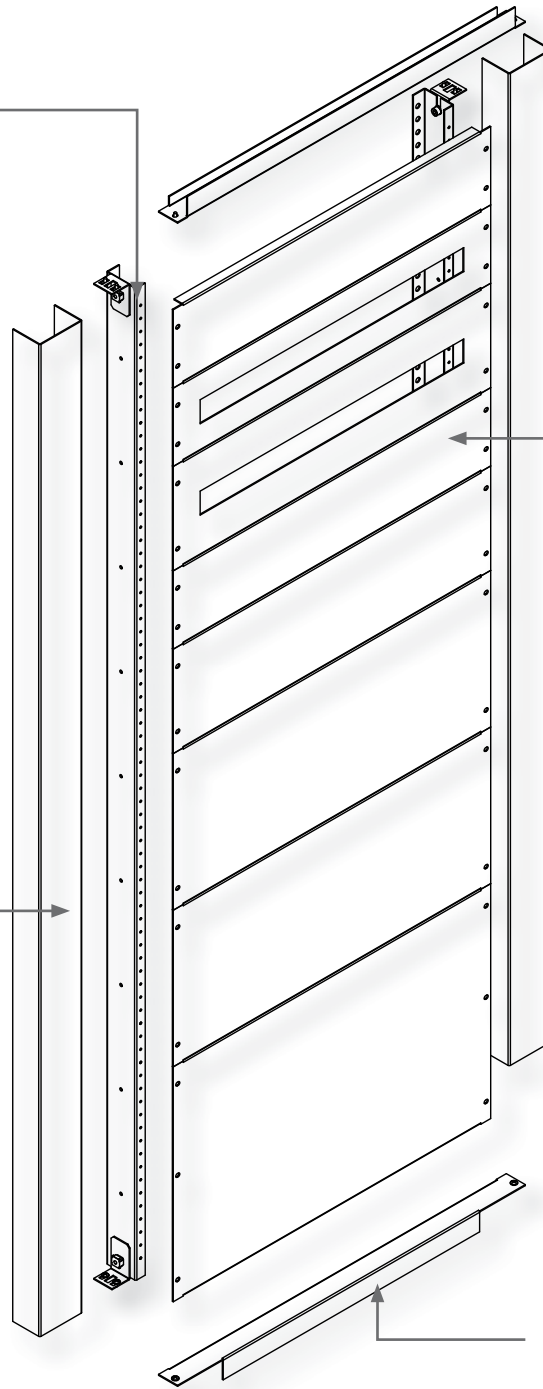

QA ACCESSORIES

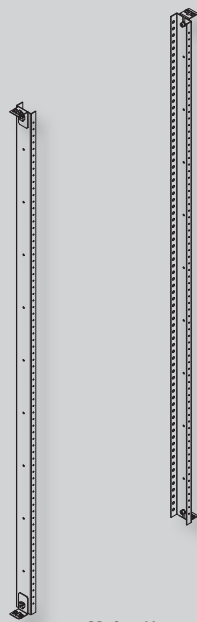

PD-Q13-M19

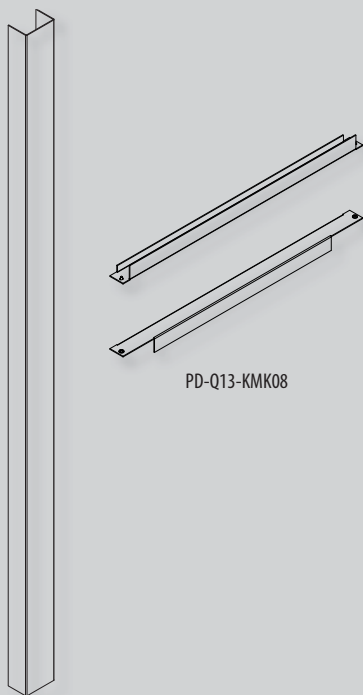

PD-Q13-KMM19

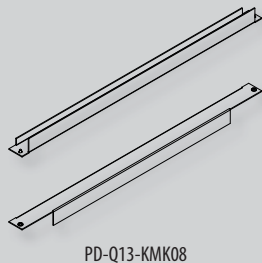

PD-Q13-KMK08

Modular system - modular rails

- For mounting of modular devices.
 - PD-Q13-KM covers are for covering devices from front.
 - Vertical rails are channel formed from 2 mm steel sheet, "U" profile.
 - Galvanised finish.
 - PD-Q13-MxxA rails are for covering of Arion breakers in withdrawable design from front.
- The package contains:
 - 2 vertical rails
 - fastening material.
- "U" rails not included.*

For cabinet height [mm]	Type	Order code	Design	Weight [kg]	Package [sets]
1 800	PD-Q13-M17	OEZ:35816	depth 65 mm	11.2	1
2 000	PD-Q13-M19	OEZ:35817	depth 65 mm	12.2	1
2 200	PD-Q13-M21	OEZ:35818	depth 65 mm	13.1	1
1 800	PD-Q13-M17A	OEZ:35819	for ARION breaker (depth 35 mm)	7.2	1
2 000	PD-Q13-M19A	OEZ:35820	for ARION breaker (depth 35 mm)	7.8	1
2 200	PD-Q13-M21A	OEZ:35821	for ARION breaker (depth 35 mm)	8.4	1

Modular system - outer covers

- In flush-mounting of the modular system it is necessary to use it to reach IP20.
 - Use on sides of the cabinet or as a filler between the cabinets.
- The package contains:
 - 1 vertical outer cover
 - 2 vertical outer covers (top and bottom).

For cabinet height [mm]	Type	Order code	Cover height [mm]	Cover design	Weight [kg]	Package [sets]
1 800	PD-Q13-KMM17	OEZ:36004	–	vertical outer cover	1.17	1
2 000	PD-Q13-KMM19	OEZ:36005	–	vertical outer cover	1.30	1
2 200	PD-Q13-KMM21	OEZ:36006	–	vertical outer cover	1.42	1
600	PD-Q13-KMK06	OEZ:35846	40	horizontal outer covers	0.31	1
800	PD-Q13-KMK08	OEZ:35847	40	horizontal outer covers	0.44	1
1 000	PD-Q13-KMK10	OEZ:35848	40	horizontal outer covers	0.55	1
1 200	PD-Q13-KMK12	OEZ:35849	40	horizontal outer covers	0.70	1

QA ACCESSORIES

PD-Q13-KM01508
 PD-Q13-KMV01508
 PD-Q13-KMV01508
 PD-Q13-KM01508
 PD-Q13-KM02008
 PD-Q13-KM01508
 PD-Q13-KM03008
 PD-Q13-KM04508

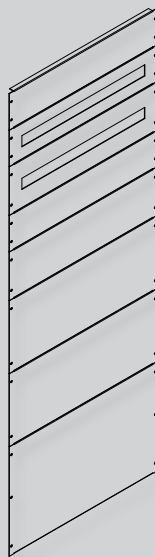

Modular system – covers

- For mounting into the modular system.
 - Plastic with 45 mm cut-out or without cut-out.
 - Total height for covering = (cabinet height - 100 mm).
 - Outer covers are for covering of the remaining parts.
- The package contains:
 - 1 cover
 - fastening material.

For cabinet width [mm]	Type	Order code	Cover height [mm]	Cover design	Cut-out width [mm]	Number of modules 18 mm	Weight [kg]	Package [pcs]
600	PD-Q13-KMV01506	OEZ:35822	150	cut-out 45 mm	385	21	0.23	1
800	PD-Q13-KMV01508	OEZ:35823	150	cut-out 45 mm	583	32	0.27	1
1 000	PD-Q13-KMV01510	OEZ:35824	150	cut-out 45 mm	2x390	42	0.34	1
1 200	PD-Q13-KMV01512	OEZ:35825	150	cut-out 45 mm	3x320	51	0.44	1
600	PD-Q13-KM01506	OEZ:35830	150	without cut-out	–	–	0.25	1
800	PD-Q13-KM01508	OEZ:35831	150	without cut-out	–	–	0.33	1
1 000	PD-Q13-KM01510	OEZ:35832	150	without cut-out	–	–	0.48	1
1 200	PD-Q13-KM01512	OEZ:35833	150	without cut-out	–	–	0.56	1
600	PD-Q13-KMV0206	OEZ:35826	200	cut-out 45 mm	385	21	0.30	1
800	PD-Q13-KMV0208	OEZ:35827	200	cut-out 45 mm	583	32	0.45	1
1 000	PD-Q13-KMV0210	OEZ:35828	200	cut-out 45 mm	2x390	42	0.59	1
1 200	PD-Q13-KMV0212	OEZ:35829	200	cut-out 45 mm	3x320	51	0.74	1
600	PD-Q13-KM02006	OEZ:35834	200	without cut-out	–	–	0.33	1
800	PD-Q13-KM02008	OEZ:35835	200	without cut-out	–	–	0.48	1
1 000	PD-Q13-KM02010	OEZ:35836	200	without cut-out	–	–	0.62	1
1 200	PD-Q13-KM02012	OEZ:35837	200	without cut-out	–	–	0.76	1
600	PD-Q13-KM03006	OEZ:35838	300	without cut-out	–	–	0.46	1
800	PD-Q13-KM03008	OEZ:35839	300	without cut-out	–	–	0.64	1
1 000	PD-Q13-KM03010	OEZ:35840	300	without cut-out	–	–	0.95	1
1 200	PD-Q13-KM03012	OEZ:35841	300	without cut-out	–	–	1.06	1
600	PD-Q13-KM04506	OEZ:35842	450	without cut-out	–	–	0.92	1
800	PD-Q13-KM04508	OEZ:35843	450	without cut-out	–	–	1.30	1
1 000	PD-Q13-KM04510	OEZ:35844	450	without cut-out	–	–	1.80	1
1 200	PD-Q13-KM04512	OEZ:35845	450	without cut-out	–	–	2.20	1

QA ACCESSORIES

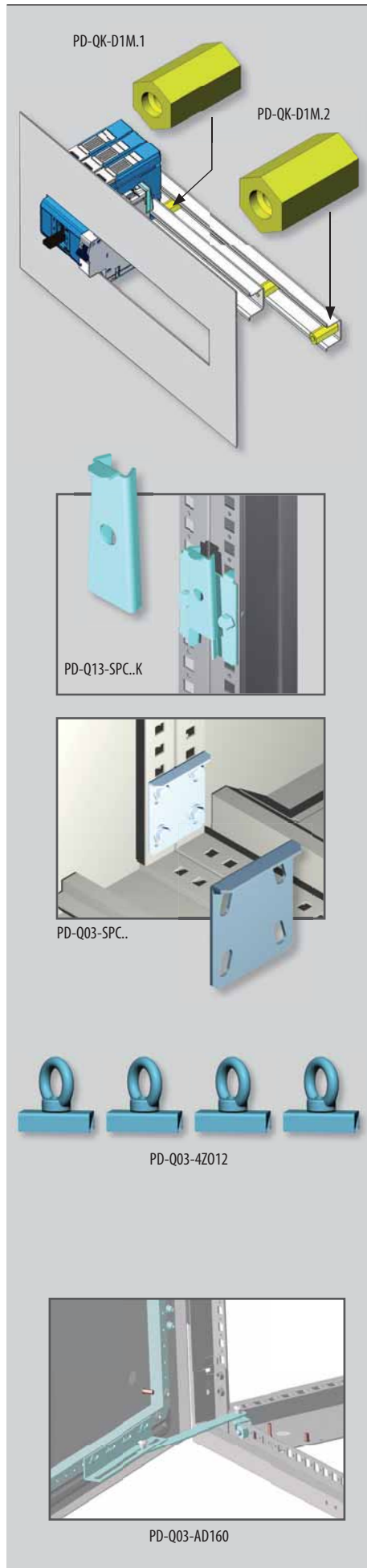

Spacers

- For depth off set of BC circuit breakers and joining of profiles with modular devices.
- Used with 15 mm "U" rail.
- Mounting to modular system.
- The package contains:
 - 10 spacers
 - fastening material.

Use	Type	Order code	Spacer			Weight [kg]	Package [sets]
			design	thread	height [mm]		
Joining BC profile and modular devices, mounting on 15 mm "U" rails	PD-QK-D1M51	OEZ:33786	internal threading	M5	19	0.23	1
	PD-QK-D1M61	OEZ:33789	internal threading	M6	19	0.28	1
	PD-QK-D1M81	OEZ:33791	internal threading	M8	19	0.44	1
Off set of BC circuit breakers from modular system of QA cabinets, mounting on 15 mm "U" rail	PD-QK-D1M52	OEZ:33787	internal threading	M5	22	0.26	1
	PD-QK-D1M62	OEZ:33790	internal threading	M6	22	0.31	1
	PD-QK-D1M82	OEZ:33792	internal threading	M8	22	0.47	1

Cabinet joining kits

- For mechanical joining cabinets into groups.
- Galvanised finish.
- The package contains:
 - 6 pcs connectors
 - self-adhesive sealing
 - fastening material.

For cabinet height [mm]	Type	Order code	Weight [kg]	Package [sets]
1 800	PD-Q03-SPC18	OEZ:19749	1.35	1
2 000	PD-Q03-SPC20	OEZ:19750	1.35	1
2 200	PD-Q03-SPC22	OEZ:19751	1.35	1
1 800	PD-Q13-SPC18K	OEZ:35850	1.50	1
2 000	PD-Q13-SPC20K	OEZ:35851	1.50	1
2 200	PD-Q13-SPC22K	OEZ:35852	1.50	1

Lifting lugs

- Screws with M12 threading.
- 250 kg load capacity per lifting lug.
- The package contains:
 - 4 lifting lugs
 - fastening material.

Type	Order code	Weight [kg]	Package [sets]
PD-Q03-4Z012	OEZ:19780	1.21	1

Door catch

- For door opening angle 120°, 160°.
- The package contains:
 - 1 arrestment
 - fastening material.

Type	Order code	Weight [kg]	Package [sets]
PD-Q13-AD160	OEZ:37166	0.27	1

QA ACCESSORIES



PD-QK-UVD



PD-QK-UVZ



PD-QK-UBB5

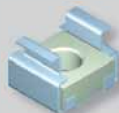

PD-QK-M8



PD-QK-DVA06



PD-QK-ARAL7035

Locks

- Swivel door handle inserts serve for quick replacement with another lock insert for the standard issue double-bar 5 mm double-bar 5mm insert.
- The package contains:
 - 1 insert
 - fastening material necessary for replacing original lock.

Type	Order code	Lock design	Weight [kg]	Package [sets]
PD-QK-UVD	OEZ:20748	Insert „D”	0.08	1
PD-QK-UVZ	OEZ:20749	Locking insert	0.08	1
PD-QK-UBD	OEZ:17454	D key (Czech D)	0.05	1
PD-QK-UBB5	OEZ:17455	DB5 key (double-bar 5 mm)	0.04	1

Cage nuts

- The package contains:
 - 1 nut.

Type	Order code	Nut design	For hole [mm]	Weight [kg]	Package [pcs]
PD-QK-M6	OEZ:17432	M6	8.3 x 8.3	0.005	1
PD-QK-M8	OEZ:17433	M8	12.3 x 12.3	0.008	1
PD-QK-M10	OEZ:17434	M10	12.3 x 12.3	0.010	1

Data pockets

- The package contains:
 - 1 data pocket.

Type	Order code	Design	Weight [kg]	Package [pcs]
PD-QK-DVA4PS	OEZ:34377	plastic, self-adhesive	0.15	1
PD-QK-DVA06	OEZ:35854	screwed for 600 mm cabinet width	0.15	1
PD-QK-DVA08	OEZ:35855	screwed for 800 mm cabinet width	0.15	1

Repair vanishes

- For small paint corrections or treating edges of additionally created openings.
- Aerosol can.
- Fast drying.
- Colour RAL 7035.
- Contents 400 ml.
- The package contains:
 - 1 aerosol can.

Type	Order code	Weight [kg]	Package [sets]
PD-QK-ARAL7035	OEZ:20407	0.52	1

QA ACCESSORIES



PD-Q13-DSK

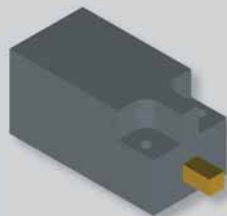
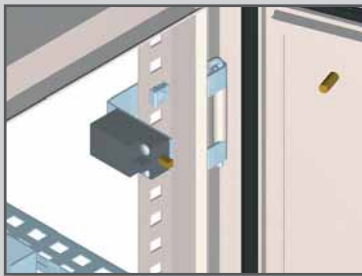

PD-QK-SK11



PD-Q13-OSL



Illustrative picture

Door switch brackets

- For mounting PD-QK-SK11 door switch.
- Galvanised finish.
- The package contains:
 - 1 holder
 - fastening material.

Type	Order code	Weight [kg]	Package [sets]
PD-Q13-DSK	OEZ:35853	0.2	1

Door switch

- For mounting to QA55 and QA40 cabinets, it is necessary to use a PD-Q13-DSK door switch holder.
- 1 make and 1 break contact.
- For lighting, climate control and other circuits.
- AC 15; AC 400 V; 1.8 A; U, 500 V.
- The package contains:
 - 1 door switch
 - fastening material.

Type	Order code	Weight [kg]	Package [sets]
PD-QK-SK11	OEZ:20751	0.1	1

Light

- For switchboard lighting.
- LED.
- 4 W; AC 230 V.
- Mode switch:
 - MODE 1, MODE 2 - IR sensor control
 - CONSTANT – permanently switched on, e.g. door switch control
- IR sensor.
- Removable terminal block for Cu conductors 0.5 ÷ 2.5 mm² connection.
- Rail for cable holders Sonap PD-QK-LKU... is used for fastening at the top.
- The package contains:
 - 1 light
 - fastening material.

Type	Order code	Weight [kg]	Package [sets]
PD-Q13-OSL	OEZ:44377	0.24	1

Dimensions

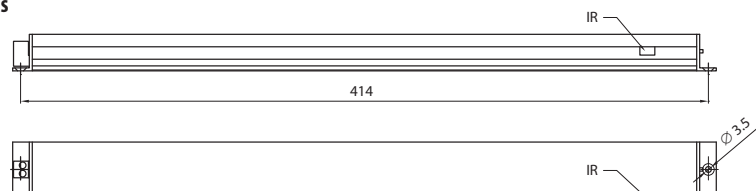

QA ACCESSORIES

Spare parts

Type	Order code	Description	Weight [kg]	Package [pcs]
ND-Q13-PD	OEZ:45484	Hinge for QA, fastening material, 1 pc	0.15	1
ND-Q13-ZT	OEZ:45485	Closing rods stop for QA single door, fastening material, 1 pc	0.03	1
ND-Q13-UMECH	OEZ:45486	Closing mechanism for QA, fastening material	0.15	1
ND-Q13-UVED	OEZ:45487	Tie rod guide for closing of QA, set of 2 plastic parts and nuts	0.01	1
ND-Q13-UK	OEZ:37848	Swivel door handle for QA, 1 pc	0.10	1
ND-Q13-DZK	OEZ:41368	Rear cover holder for QA, fastening material, 1 pc	0.01	1
ND-Q13-UVDB5	OEZ:38751	Inserts DB5 for swivel handle, for QA	0.08	1
ND-Q13-DA1	OEZ:34171	Mounting plate holder, fastening material, set of 4 pcs	1.70	1
ND-Q11-KH0604	OEZ:39237	Upper cover, IP55, for QA55(40)-..0604	1.60	1
ND-Q11-KH0605	OEZ:39248	Upper cover, IP55, for QA55(40)-..0605	2.10	1
ND-Q11-KH0606	OEZ:41360	Upper cover, IP55, for QA55(40)-..0606	2.60	1
ND-Q11-KH0804	OEZ:43053	Upper cover, IP55, for QA55(40)-..0804	2.40	1
ND-Q11-KH0806	OEZ:41507	Upper cover, IP55, for QA55(40)-..0806	4.60	1
ND-Q11-KH0808	OEZ:39857	Upper cover, IP55, for QA55(40)-..0808	5.40	1
ND-Q11-KH1004	OEZ:41535	Upper cover, IP55, for QA55(40)-..1004, sets of 2 pcs	3.00	1
ND-Q11-KH1005	OEZ:44571	Upper cover, IP55, for QA55(40)-..1005, sets of 2 pcs	3.90	1
ND-Q11-KH1006	OEZ:43849	Upper cover, IP55, for QA55(40)-..1006, sets of 2 pcs	4.80	1